

PREFACE

Thank you for selecting a Hero MotoCorp **SUPER SPLENDOR PROGRAMMED FI**. We wish you many miles of continued riding pleasure in the years ahead.

We at Hero MotoCorp, are committed to demonstrate excellence in our environment performance on a continual basis, as an intrinsic element of our corporate philosophy. To achieve this we commit ourselves to continue product innovations to improve environment compatibility, comply with all applicable legislation including environment legislation and strengthen the green supply chain.

Your vehicle is conforming to latest (Bharat stage-VI norms) regulation for emission, safety & noise levels. We are also using non asbestos brake shoes/pads and engine gaskets which are environment friendly in nature.

This vehicle is fitted with a lighting feature known as “Automatic Headlamp ON”. The feature is mandated for all 2 Wheelers by Ministry of Road Transport & Highways (Government of India) vide notification GSR 188 (E) dated 22nd February 2016. This feature helps in conspicuity for improving rider safety. The headlamp of this vehicle will always be lit ON when the engine gets ON.

This booklet is your guide to the basic operation and maintenance of your new Hero MotoCorp **SUPER SPLENDOR PROGRAMMED FI**. Please take time to read it carefully. As with any fine machine, proper care and maintenance are essential for trouble-free operation and optimum performance.

Your Authorised Hero MotoCorp dealer will be glad to provide further information or assistance and is equipped to handle your future service needs.

Let us make this world a safer, healthier and more environment friendly place.



NOTE

ALL INFORMATION, ILLUSTRATION, PHOTOGRAPH, DIRECTIONS, SPECIFICATIONS AND OTHER CONTENTS COVERED IN THIS OWNER'S MANUAL ARE BASED ON THE LATEST PRODUCT INFORMATION AVAILABLE AT THE TIME OF ITS PRINTING APPROVAL, AND THE ACCURACY OR CORRECTNESS OF THE SAME IS NOT UNDERTAKEN OR GUARANTEED.

Hero MotoCorp Ltd **RESERVES THE RIGHT TO MAKE CHANGES IN ITS CONTENTS AT ANY TIME WITHOUT NOTICE AND/OR INCURRING ANY OBLIGATION, WHATSOEVER. NO ONE IS ALLOWED TO REPRODUCE ANY PART OF THIS PUBLICATION WITHOUT OBTAINING PRIOR WRITTEN PERMISSION FROM** Hero MotoCorp Ltd.

ACCESSORIES SHOWN MAY NOT BE THE PART OF STANDARD FITMENT. IT IS OUR ENDEAVOUR TO CONSTANTLY IMPROVE OUR PRODUCTS. THIS COULD LEAD TO CHANGE IN PRODUCT SPECIFICATIONS WITHOUT NOTICE. Hero MotoCorp Ltd **'SUPER SPLENDOR PROGRAMMED FI' COMPLIES WITH THE LATEST EMISSION NORMS.**

ADDENDUM

As per Ministry of Road Transport & Highways (Government of India) vide Notification G.S.R. 540(E), Hemostatic agent is excluded from first aid kit in reduction from existing kit effective from 31st August 2020.

CONTENTS

	Pg. No.	Pg. No.
VEHICLE IDENTIFICATION	1	28
VEHICLE VIEWS	2	31
VEHICLE SPECIFICATION	5	32
ACCESSORIES & MODIFICATIONS	7	33
ANTI-THEFT TIPS	7	34
VEHICLE SAFETY	8	35
• Important safety information	8	37
• Protective apparel	9	39
SAFE RIDING TIPS	10	40
TIPS FOR HEALTHY ENVIRONMENT	11	40
PARTS FUNCTION	12	43
• Ignition switch	12	43
• Instruments and Indicators	13	48
FEATURES	14	48
HANDLEBAR SWITCHES CONTROL	14	51
i3s (IDLE STOP START SYSTEM)	16	52
SIDE STAND INDICATOR/SWITCH	18	55
FUEL TANK	18	55
SEAT LOCK/HELMET HOLDER	19	57
USB CHARGER (OPTIONAL)	20	57
PRE-RIDE INSPECTION	21	58
STARTING THE ENGINE	22	58
RIDING	24	59
BRAKING	24	59
PARKING	25	60
TOOL KIT/FIRST AID KIT	25	62
CLEANING AND WASHING OF VEHICLE	26	
MAINTENANCE	26	
SAFETY PRECAUTION	27	
MAINTENANCE SCHEDULE		28
SPARK PLUG INSPECTION		31
ENGINE OIL		32
ENGINE OIL FILTER ELEMENT		33
OIL FILTER SCREEN		34
AIR CLEANER		35
VALVE CLEARANCE ADJUSTMENT		37
CLUTCH LEVER FREE PLAY		39
THROTTLE OPERATION		40
DRIVE CHAIN SLACKNESS		40
DRIVE CHAIN SLIDER INSPECTION		43
BRAKES		43
SUSPENSION		48
WHEEL		48
MAIN/SIDE STAND LUBRICATION		51
TUBELESS TYRES		52
NUTS, BOLTS & FASTENERS		55
BATTERY		55
FUSE REPLACEMENT		57
STOP LAMP SWITCH		57
HEADLAMP FOCUS ADJUSTMENT		58
CATALYTIC CONVERTER		58
EVAPORATIVE EMISSION CONTROL SYSTEM		59
POLISHING OF VEHICLE		59
BASIC TROUBLESHOOTING		60
ROAD SIGNS		62
WARRANTY		
HERO GENUINE PARTS		
ZONAL/REGIONAL/AREA OFFICES		

VEHICLE IDENTIFICATION



Vehicle Identification Number (VIN)

Location: Stamped on the right side of the steering head tube.

Engine No.

Location: Stamped on the lower side of the left crankcase.

VIN: MBLJAW18#####

MBL	JAW18	#	#	#	#	#####
Manufacturer code	Vehicle Description	Check Digit	Model Year	Plant Code	Month of Manufacturing	Production Serial Number

Engine No.: JA07AB#####

JA07AB	#	#	#	#####
Engine Description	Year of Manufacturing	Assembly Plant	Month of Manufacturing	Serial Number

Model: SUPER SPLENDOR PROGRAMMED FI

Variant	VIN	Engine
Electric start/Front disc/Cast wheel	JAW18	JA07AB
Electric start/Front drum/Cast wheel	JAW17	JA07AB

VIN and Engine No. may be required:

1. During registration of the vehicle.
2. For dealing with legal & insurance departments.

VEHICLE VIEWS

TOP VIEW

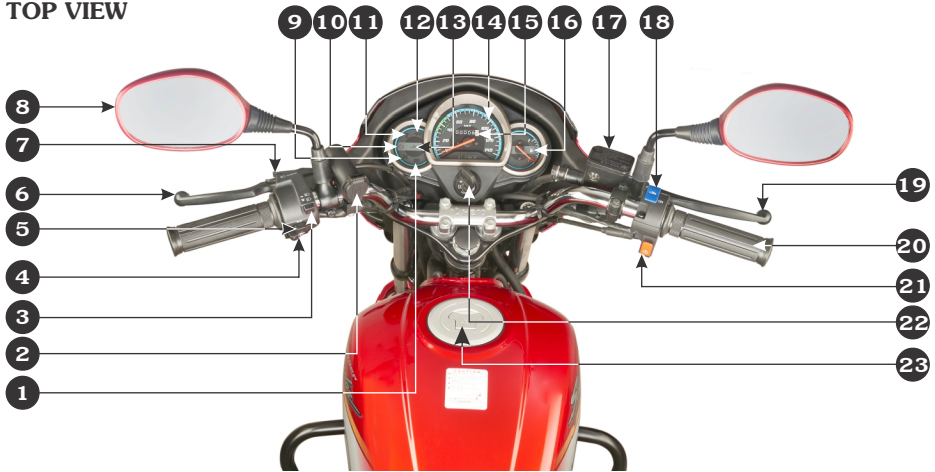

- | | |
|---|--|
| (1) High beam indicator | (12) Turn signal indicator |
| (2) USB charger (Optional) | (13) i3s indicator |
| (3) Dimmer switch | (14) Speedometer |
| (4) Horn switch | (15) Odometer |
| (5) Turn signal switch | (16) Fuel indicator |
| (6) Clutch lever | (17) Front brake master cylinder/Reservoir |
| (7) Passing switch | (18) i3s switch |
| (8) Rear view mirror | (19) Front brake lever |
| (9) Neutral indicator | (20) Throttle grip |
| (10) Programmed FI malfunction indicator lamp (MIL) | (21) Electric starter switch |
| (11) Side stand indicator | (22) Ignition switch with steering lock |
| | (23) Fuel tank cap |

***Accessories and features shown may not be part of standard fitment.**

LEFT SIDE VIEW



- | | | |
|--------------------------|---|-----------------------------|
| (1) Leg guard (Optional) | (8) Saree guard with women pillion step | (14) Rear grip |
| (2) Rider footrest | (9) Seat lock | (15) Helmet holder (inside) |
| (3) Gear shift pedal | (10) Rear fender | (16) Battery (inside) |
| (4) Main stand | (11) Rear turn signal lamp | (17) Side stand switch |
| (5) Left side cover | (12) Rear reflex reflector | (18) Front suspension |
| (6) Side stand | (13) Tail/Stop lamp | (19) Front fender |
| (7) Pillion footrest | | (20) Front reflex reflector |

***Accessories and features shown may not be part of standard fitment.**

RIGHT SIDE VIEW



- | | | |
|----------------------------|-----------------------------|--------------------------|
| (1) #CBS Actuator (inside) | (7) Kick starter pedal | (13) Throttle body |
| (2) #Brake fluid reservoir | (8) #Caliper assembly | (14) ECU (inside) |
| (3) Right side cover | (9) #Front brake disc | (15) Seat |
| (4) Starter motor | (10) Front turn signal lamp | (16) Rear shock absorber |
| (5) Brake pedal | (11) Headlamp | (17) Exhaust muffler |
| (6) Oil level dipstick | (12) Front visor | |

Disc Variant

***Accessories and features shown may not be part of standard fitment.**

VEHICLE SPECIFICATION

ITEM		SPECIFICATIONS
Dimensions		
Overall length		2042 mm
Overall width	Disc-Drum	740 mm
	Drum-Drum	714 mm
Overall height		1102 mm
Wheelbase		1273 mm
Saddle height		799 mm
Ground clearance		180 mm
Weight		
Kerb weight	Disc-Drum	123 kg
	Drum-Drum	122 kg
Payload		130 kg
Capacities		
Engine oil		0.95 litre at disassembly and 0.75 litre at draining
Fuel tank capacity		12 litres
Engine		
Maximum power		8 kW @ 7500 r/min
Maximum torque		10.6 N-m @ 6000 r/min
Bore and stroke		52.4x57.8 mm
Compression ratio		9.9:1
Displacement		124.7 cc
Spark plug		NGK-CPR 7EA9, RG8YC (Federal Mogul)
Spark plug gap		0.8-0.9 mm
Valve clearance	Intake (cold)	0.08 mm
	Exhaust (cold)	0.12 mm
Idle speed		1400±100 r/min
Chassis and suspension		
Front suspension		Telescopic hydraulic shock absorbers
Rear suspension		Swingarm with 5 step adjustable hydraulic shock absorbers
Caster angle		26°

VEHICLE SPECIFICATION

ITEM		SPECIFICATIONS
Trail length		92 mm
Tyre size	Front	80/100-18 47P (Tubeless tyre)
	Rear	90/90-18 51P (Tubeless tyre)
Brakes	Front (Disc type)	Dia. 240 mm
	Front (Drum type)	Dia. 130 mm
	Rear (Drum type)	Dia. 130 mm
Front & rear wheels		Cast wheels
Transmission		
Primary reduction		3.35 (67/20)
Final reduction		3.214 (45/14)
Transmission		5 speed transmission
Gear ratio, 1 st		3.17 (38/12)
2 nd		1.83 (33/18)
3 rd		1.272 (28/22)
4 th		1.04 (26/25)
5 th		0.923 (24/26)
Electricals		
Battery		*MF battery 12V-4Ah/ETZ5
Alternator		140 W @ 5000 r/min
Starting system		Kick/Electric start
Headlamp (High/Low)		12V-35W/35W Halogen bulb-**MFR
Tail/Stop lamp		12V-21/5W-**MFR
Turn signal lamp		12V-10Wx4 (Amber bulb) with clear lens-**MFR
Meter illumination		12V-1.7Wx3
Neutral indicator		12V-1.7W
Turn signal indicator		12V-1.7W
Hi beam indicator		12V-1.7W
Side stand indicator		12V-0.5W (LED)
i3s indicator		12V-0.5W (LED)
Programmed FI Malfunction indicator lamp (MIL)		12V-0.5W (LED)
Fuse	Circuit fuse	15A, 10A, 10A
	Spare fuse	15A, 10A

*MF stands for Maintenance Free

**MFR stands for Multi-Focal Reflector

ACCESSORIES & MODIFICATIONS

Modifying your vehicle or using non-Hero MotoCorp accessories can make your vehicle unsafe. Before you consider making any modifications or adding an accessory, be sure to read the following information.

WARNING

- ***Improper accessories or modifications can cause a crash in which you can be seriously hurt or killed.***
- ***Follow all instructions in this owner's manual regarding accessories and modifications.***

Accessories

- Make sure that the accessory does not obscure any lamps, reduce ground clearance, limit suspension travel or steering travel, affect your riding position or interfere with operating any controls.
- Be sure electrical equipment does not exceed the vehicle's electrical system capacity (**page 6**). A blown fuse can cause a loss of lights.
- Do not pull a trailer or sidecar with your vehicle. This vehicle was not designed for these attachments, and their use can seriously impair your vehicle's handling.

Modifications

We strongly advise you not to remove any original equipment or modify your vehicle in any way that would change its design or

operation. Such changes could seriously impair your vehicle's handling, stability and braking, making it unsafe to ride. Removing or modifying your lamps, mufflers, emission control system or other equipment can also make your vehicle illegal.

ANTI-THEFT TIPS

- Always lock the steering and never leave the key in the ignition switch. This sounds simple but people do forgets.
- Be sure the registration information for your vehicle is accurate and correct.
- Park your vehicle in a locked garage whenever possible.
- Use an additional anti-theft device of good quality.
- Never park your vehicle in an isolated area. Park as far as possible in a designated area.
- Enter your name, address and phone number in this Owner's Manual and keep it in your vehicle at all times. Many times stolen vehicles are identified by information in the Owner's Manuals that are still with them.

NAME: _____

ADDRESS: _____

PHONE NO.: _____

VEHICLE SAFETY IMPORTANT SAFETY INFORMATION

Your vehicle can provide many years of service and pleasure if you take responsibility for your own safety and understand the challenges you can meet on the road.

There is much that you can do to protect yourself when you ride. You will find many helpful recommendations throughout this manual. Following are a few that we consider most important.

Always wear a helmet

It is a proven fact, helmet significantly reduces the number and severity of head injuries. So always wear a helmet and make sure your pillion rider does the same. We also recommend that you wear eye protection, sturdy boots, gloves and other protective gear.

Before riding your vehicle

Make sure that you are physically fit, mentally focused and free of alcohol and drugs. Check that you and your pillion are both wearing an approved vehicle helmet and protective apparel. Instruct your pillion on holding onto the grab rail or your waist, leaning with you in turns, and keeping their feet on the footrest, even when the vehicle is stopped.

Take time to learn & practice your vehicle

Even if you have ridden other vehicles, practice riding in a safe area to become familiar with how this vehicle works and handles, and to become accustomed to the vehicle's size and weight.

Ride defensively

Always pay due attention to other vehicles around you, and do not assume that other drivers see you. Be prepared to stop quickly or perform an evasive maneuver.

Make yourself easily visible

Some drivers do not see vehicles because they are not looking for them. To make yourself more visible, wear bright reflective clothing, position yourself so that others can see you, signal before turning or changing lanes, and use horn which will help others to notice you.

Ride within your limits

Pushing the limits is another major cause of vehicle accidents. Never ride beyond your personal abilities or faster than conditions demand. Remember that fatigue and negligence can significantly reduce your ability to make good judgements and ride safely.

Do not drink and ride

Riding under the influence of alcohol or drugs is dangerous. Alcohol can reduce your ability to respond to changing conditions and reduce the reaction time. Do not drink and ride.

Keep your vehicle in safe condition

For safe riding, its important to inspect your vehicle before every ride and perform all recommended maintenance. Never exceed load limits, and use accessories that have been recommended by Hero MotoCorp for this vehicle.

If you are involved in a crash

Personal safety is your first priority. If you or anyone else has been injured, take time to assess the severity of the injuries and whether it is safe to continue riding. Call for emergency assistance if needed. Also follow applicable laws and regulations if another person or vehicle is involved in the crash.

If you decide to continue riding, first evaluate the condition of your vehicle. If the engine is still running, turn it off. Inspect for fluid leaks, check the tightness of critical nuts and bolts, and check the handlebar, brake levers, brakes, and wheels. Ride slowly and cautiously. Your vehicle may have suffered damage that is not immediately apparent. Have your vehicle thoroughly checked at a qualified service facility as soon as possible.

PROTECTIVE APPAREL

For your safety, we strongly recommend that you always wear an approved helmet (ISI marked), eye protection, boots, gloves, long pants and a long sleeve shirt or jacket whenever you ride. Take care of loose/hanging clothes while solo/pillion riding. Although complete protection is not possible, wearing proper gear can reduce the chance of injury when you ride.

Following are suggestions to help you choose proper riding gear.



WARNING

- ***Not wearing a helmet increases the chance of serious injury or death in a crash.***
- ***Be sure you and your pillion always wear a helmet, eye protection and other protective apparel when you ride.***

Helmets and eye protection

Your helmet is your most important piece of riding gear because it offers the best protection against head injuries. A helmet should fit your head comfortably and securely. A bright coloured helmet can make you more noticeable in traffic, as can reflective strips.

An open-face helmet offers some protection, but a full-face helmet offers more. Always wear face shield or goggles to protect your eyes and help your vision.

Additional riding gear

In addition to a helmet and eye protection, we also recommend:

- Sturdy boots with non-slip soles to help protect your feet and ankles.
- Leather gloves to keep your hands warm and help prevent blisters, cuts, burns, and bruises.
- A two wheeler riding suit or jacket for comfort as well as protection. Bright coloured reflective clothing can help make you more noticeable in traffic. Be sure to avoid loose clothes that could get caught on any part of your vehicle.

SAFE RIDING TIPS

Do's:

- Always conduct simple pre-ride inspection **(page 21)**.
- Always wear a helmet (ISI marked) with chin strap securely fastened and insist on a helmet for your pillion rider.
- While riding, sit in a comfortable position with your legs close to fuel tank.
- Ride defensively and at a steady speed (between **40–50 km/hr**).
- To stop the vehicle (in IBS), press the rear brake pedal for the application of front and rear brakes simultaneously. However, for more effective braking, use both brakes simultaneously, keeping throttle in the closed position.
- Respect road signs and obey traffic rules for your own safety and that of others on the road **(page 62)**.
- During night time, dip headlamps of your vehicle for oncoming traffic, or when following another vehicle.
- Give way to others on the road and signal before you make a turn.
- To make yourself more visible, wear bright reflective clothing that fits well.
- Tightly wrap loose/hanging clothes & avoid entangling with moving parts.
- Get your vehicle serviced regularly by the Authorised Hero MotoCorp workshop.
- Before riding make sure in which mode you are riding whether with i3s switch “ON” or “OFF”.

Don't

- Never use cell phone while riding the vehicle.
- Avoid sudden acceleration, braking and turning of your vehicle.
- Never shift gears without disengaging the clutch and closing the throttle.
- Never touch any part of the hot exhaust system like muffler.
- Never ride under the influence of alcohol or drugs.
- Concentrate on the road and avoid talking to the pillion rider or others on the road.
- Do not litter the road.
- Do not cross the continuous white/yellow line in the center of the road, while overtaking.
- Do not attach large or heavy items to the handlebars, front forks, or fenders.
- Never take your hands off the steering handle while riding.

TIPS FOR HEALTHY ENVIRONMENT

The following tips shall ensure a healthy vehicle, healthy environment, and a healthy you.

- **Healthy engine:** The engine is the lifeline of every vehicle. To keep it healthy, it should be tuned regularly, which will also help reduce pollution and improve vehicle performance & fuel efficiency.
- **Regular servicing:** Get your vehicle serviced at an Authorised Hero MotoCorp workshop, as per the service schedule, for an optimum performance and keep the emission level under check.
- **Genuine spares:** Always insist on Hero MotoCorp genuine parts as spurious or incompatible spares and accessories can upset or deteriorate your vehicle's running condition.
- **Genuine engine oil:** Hero 4T Plus SAE 10W 30 SL grade (JASO MA2) engine oil recommended by Hero MotoCorp and make sure you change it every 6000 km. (with top up every 3000 kilometres) to keep the engine fit and environment healthy.
- **Noise pollution :** Noise beyond a certain decibel is pollution. Whether it is from horns or defective mufflers, excessive noise will cause headaches and discomfort.
- **Emission pollution:** Get emission of your vehicle checked by Authorised agencies atleast once every 3 months or as notified by the government from time to time.
- **Fuel saving & Reduce pollution :** Switch "OFF" the engine while waiting at traffic signal points to save fuel and reduce pollution, if the waiting period is long.
- **BS-VI grade fuel :** Always use BS-VI grade fuel to adhere BS-VI norms.

PARTS FUNCTION

Ignition switch

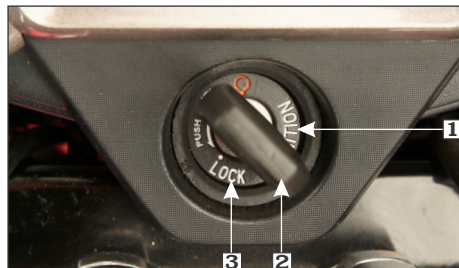
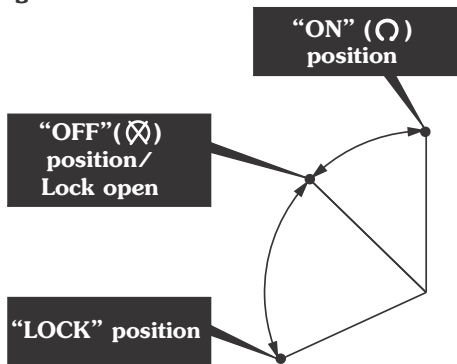

- (1) Ignition switch
- (2) Ignition key
- (3) Steering lock position

Key position	Function	Key removal
“ON” (Ⓞ)	The engine can be started, turn signal lamps, horn, tail/stop lamp and passing switch can be operated. Fuel gauge, Programmed FI malfunction indicator lamp (MIL) illuminates and i3s indicator glows for 2 seconds.	Key cannot be removed
“OFF” (⊗)	Engine cannot be started and no electrical system will be functional.	Key can be removed
“LOCK”	Steering can be locked.	Key can be removed

Instruments and Indicators

The indicators are in the speedometer panel above the headlamp. The functions are as below.

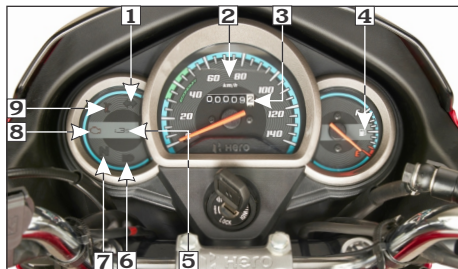

Sl. No.	Description	Function
(1)	Turn signal indicator	Indicates the turn signal lamp operation to the rider.
(2)	Speedometer	Indicates driving speed.
(3)	Odometer	Shows accumulated distance travelled.
(4)	Fuel gauge	Indicates approximate fuel quantity (page 14).
(5)	i3s indicator	Indicator glows for 2 seconds and turns “OFF” indicating that i3s system is functional.
(6)	High beam indicator	Light glows when headlamp is in Hi beam.
(7)	Neutral indicator	Light glows when vehicle is in neutral.
(8)	Programmed-FI malfunction indicator lamp (MIL)	When the ignition switch is turned “ON” the programmed FI malfunction indicator lamp (MIL) glows continuously and then should go “OFF” once the engine is started. It indicates that programmed FI system is OK. If it glows continuously there is an abnormality in the programmed FI system, it is recommended to reduce the speed and drive to the Authorised Hero MotoCorp workshop for check-up.
(9)	Side stand indicator	Light glows when the side stand is put down.

Fuel gauge

When fuel gauge needle (1) enters the red band (2), it indicates the fuel quantity is low and the fuel tank should be refilled as soon as possible.

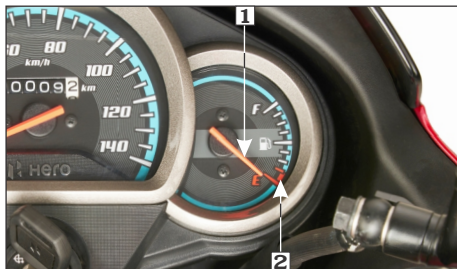

(1) Fuel gauge needle

(2) Red band

! CAUTION

Please ensure the vehicle is not used with fuel gauge needle at red band continuously. It will not only result in the vehicle running out of fuel, it may also cause serious damage to the fuel pump. Please ensure fuel is filled up as soon as the fuel gauge needle reaches red band.



NOTE

To check the fuel level indication, the vehicle should be on levelled surface and in stationary condition.

FEATURES

Steering lock

Steering lock with ignition switch, turn the ignition key (1) to “OFF” (⊗) position & turn the handlebar towards left or right & push the key downwards & turn towards “LOCK” position. After locking take out the ignition key.



(1) Ignition key

HANDLEBAR SWITCHES CONTROL

Left handlebar controls

1. Passing switch

Gives an indication for passing ahead.
Press passing lamp switch(1) to operate the passing lamp.

2. Clutch switch

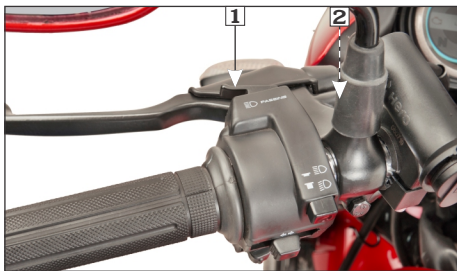

There is a clutch switch (2) provided for the safety of the rider. The vehicle cannot be started by electric starter switch until the clutch lever is operated when the vehicle is engaged in gear.



(1) Passing switch

(2) Clutch switch

3. Headlamp dimmer switch

The headlamp operates only when the engine is running or when passing switch is operated. Select “” for high beam and “” for low beam.

4. Turn signal lamp switch (↵ ↻)

Shift the turn signal lamp switch (4) sideways for right/left indications and leave it to come back to its normal position on its own.

IMPORTANT: To switch “OFF” the turn signal after completing the turn, gently push inside.

5. Horn switch (📢)

Press the horn switch (5) to operate the horn.



(3) Headlamp dimmer switch

(4) Turn signal lamp switch (5) Horn switch

Right handlebar controls

1. Electric starter switch (🔌)

Ensure starter switch (1) is operated when the vehicle is in neutral gear. If the vehicle is engaged in gear, press the clutch lever before operating the starter switch. Release starter switch after the engine has started.

! CAUTION

- *If electric starter switch is pressed continuously and engine does not start, cranking of engine will stop after 5 secs. After that rider again needs to press the electric starter switch.*
- *If engine started, cranking of the engine will stop after r/min reaches more than 1000 r/min under normal condition.*

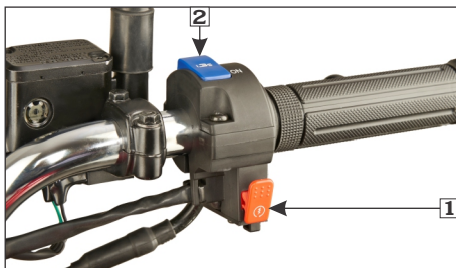

(1) Electric starter switch (2) i3s switch

2. i3s switch

There is an i3s switch (2) provided to enable the rider for turning i3s mode “ON” or “OFF” based on the traffic conditions.

i3s (IDLE STOP START SYSTEM)

Starting & Warm up the engine:

Keep the i3s switch (1) to “OFF” position. Turn the ignition key to “ON” (⊙) position.



(1) i3s switch

The i3s indicator (2) will glow on the speedometer console for 2 seconds and turn “OFF”. For the activation of i3s system, start the engine and let it idle till the engine gets warmed up or temperature reaches more than 75°C.



(2) i3s indicator

Initial activation of the i3s system:

Keep the i3s switch (1) to “ON” position. Turn the ignition key to “ON” (⊙) position. The i3s indicator (2) on the speedometer console will glow for 2 seconds and turn “OFF”. Start the vehicle (in neutral and clutch lever released condition) with less than 2000 r/min and let it idle till engine temperature reaches more than 75°C. The engine will cut-off in 30 seconds. After the first stop start, every subsequent stop will be in 5 seconds.

In this condition, the engine can be restarted either with clutch lever, kick or electric start.

Driving with i3s switch in “ON” position:

While driving, if the engine is kept idling (while waiting in a traffic signal), the engine will cut off in 5 seconds. (The vehicle should be in stand still condition, with neutral gear position at less than 2000 r/min with clutch lever/throttle is in released position and engine is warmed up). The i3s indicator will be continuously blinking in the speedometer indicating that vehicle stopped in i3s condition. By pressing the clutch lever, the engine will start again and gear can be engaged to move the vehicle.



NOTE

- *If vehicle stops in i3s condition and kept idle for more than 500 secs (ignition switch is “ON” position) i3s function will be deactivated and cannot be started by pressing the clutch lever, rider can only start the vehicle with electric or kick start.*
- *If engine is stopped by any means other than i3s function, i3s indicator will not glow/blink in the speedometer. In this condition, vehicle will not start by pressing the clutch lever. Vehicle can be started by using kick or electric start.*
- *If all the required i3s conditions are met, i3s indicator will glow for 5 secs before the engine cuts-off.*

Driving with i3s switch in “OFF” position:

While driving in a traffic jam/or very dense traffic where the vehicle has to encounter a stop and go situation, the i3s switch can be changed to “OFF” position. Once this is done,

the i3s system will not work and the vehicle will be in normal operating conditions as other vehicles and no special functions will be performed.



NOTE

- *The i3s system will not function if rider puts the i3s switch to “OFF” position.*
- *If the battery voltage is low and engine r/min is less than 2000, there will be 3 continuous blinks after every 6 secs.*
- *If the low battery voltage is detected while the ignition key is in “ON” position or engine is in running condition, the i3s function will be deactivated or may not function properly until the rider turns the ignition switch to “OFF” (⊗) position and then back to “ON” (○) position.*
- *If the vehicle is driven without battery or with the dead battery and the engine r/min is less than 2000. The i3s indicator on the speedometer will blink continuously at every 1.5 secs.*
- *If the vehicle has fallen down, i3s function may not work properly. Before restarting the engine you must turn the ignition switch to “OFF” (⊗) position and then back to “ON” (○) position.*
- *If the battery is in healthy condition and the i3s system does not work properly, it is recommended to visit your Authorised Hero MotoCorp workshop.*
- *i3s system will not function properly if the vehicle battery is low/dead or driven without battery.*
- *If vehicle diagnoses with any problem in electronic control unit (ECU) the i3s function will not work.*

SIDE STAND INDICATOR/SWITCH

For the safety of the customer a side stand indicator (1) is provided.



(1) Side stand indicator

A side stand switch (2) is provided in the side stand, when the vehicle is parked on side stand (Ignition switch “ON”), the switch enables the side stand indicator lamp to glow on the speedometer panel.



(2) Side stand switch

FUEL TANK

Fuel tank capacity is 12 litres (Be sure to fill the fuel tank when fuel gauge needle enters red band).

- To remove the fuel tank cap (1), open the key hole cover (2) and insert the ignition key (3) turn it clockwise and remove the cap.



(1) Fuel tank cap

(2) Key hole cover

(3) Ignition key

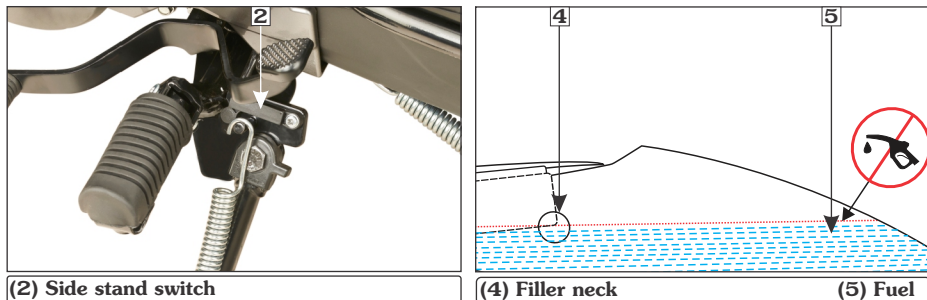

(4) Filler neck

(5) Fuel

- Do not overfill the tank. There should be no fuel (5) in the filler neck (4).
- For locking, position the cap with “▲” mark facing towards the front, back on the opening and press gently. The key springs back to the normal position and the cap gets locked.

! CAUTION

Do not park the vehicle under direct sunlight as it causes evaporation of petrol due to heat and deterioration of paint gloss due to ultra violet rays.

! WARNING

Petrol is extremely flammable and is explosive under certain conditions. Refill in a well ventilated area with the engine stopped. Do not smoke or allow flames or sparks in the area where the vehicle is refilled or where petrol is stored.

SEAT LOCK

Location : On the rear left side of the seat, below the rear cowl.

Operation : To unlock the seat, insert the ignition key (1) and turn in clockwise direction. To install, engage the hook on the underside of the seat with the frame and push on the top rear side of the seat until the lock clicks.

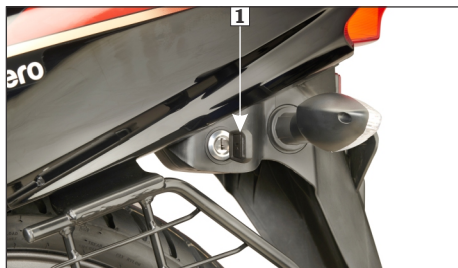

(1) Ignition key

HELMET HOLDER

The helmet holder is located below the seat. Remove the seat. Hang the helmet on the helmet holder (1) by using wire helmet set (2) (optional). Install the seat (3) and lock it securely.

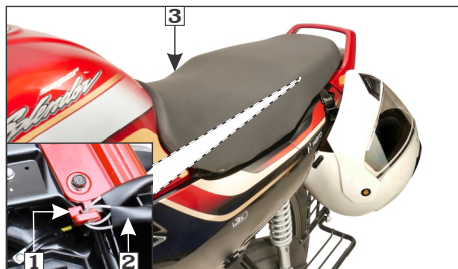

(1) Helmet holder hook
(2) Wire helmet set (optional) (3) Seat

⚠ WARNING

- *Riding with a helmet attached to the holder can interfere with the rear wheel of suspension and could cause a crash in which you can be seriously hurt or killed.*
- *Use the helmet holder only while parked. Do not ride with a helmet secured by the holder.*

USB CHARGER (OPTIONAL)

A USB charger (1) with a cap (2) located on the left handlebar to charge your mobile phone safely while riding.

To connect a mobile phone charger, first remove the cap from the USB charger and then plug in the charger cable to it.

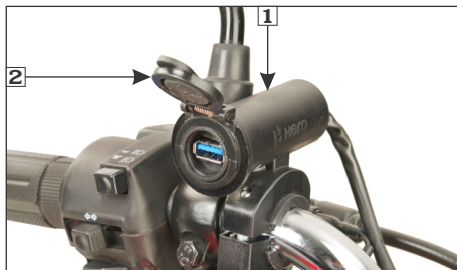

(1) USB charger

(2) Cap

Use of non-standard USB cable may cause damage to the mobile phones.

Hero MotoCorp will not be responsible for damages caused due to use of non standard USB cable.

! CAUTION

- *Always place the device in a soft clean cloth/towel to avoid any damage due to road shocks while riding.*
- *This port is for charging compatible USB devices.*
- *Multiple charging of USB devices have to be avoided, simultaneous charging may lead to slow or no charging.*
- *Do not leave the USB device and USB cable in the fuel tank cover (optional) when the vehicle is parked.*
- *Charge your device only when the engine is operational/while riding. Charging the USB device when the engine is "OFF" would lead to early discharge of battery.*

📖 NOTE

- *Do not apply any soap solution, oil or grease inside the USB charger.*
- *Any personal belongings have to be removed before water washing to avoid damage.*
- *Always keep the USB port cap closed after use to prevent dust or water entry during rains/water wash.*
- *Do not direct water jet towards the port even with cap closed to avoid any short circuit. Always dry the area using a dry cloth or moisture free compressed air before use.*

PRE-RIDE INSPECTION

You should conduct pre-ride inspection before riding the vehicle to enhance riding comfort and safety. Clean your vehicle regularly. It protects the surface finish. Avoid cleaning with products that are not specifically designed for vehicle surfaces. Inspect your vehicle very day before you start the engine. The items listed here will only take a few minutes, and in the long run they can save time, expense and possibly your life. Please follow the tips as given below:

- **Engine oil level**—Check and top up engine oil if required (**page 32**). Check for leaks.
- **Programmed FI malfunction indicator lamp (MIL)**—When the ignition switch is turned “ON” the programmed FI malfunction indicator lamp(MIL) glows continuously and then should go “OFF” once the engine is started.
- **Fuel level**—Ensure sufficient fuel is available in your fuel tank for journey. Vehicle should not be operated with fuel gauge needle at red band continuously (**page 14**). Check for leaks.
- **Front brake (Disc type)**—Check for correct brake fluid level in the master cylinder (**page 43**).
- **Front and Integrated brakes (Drum type)**—Check operation. Adjust free play if necessary (**page 45**).
- **Rear brake (For IBS)**—Check for correct brake fluid level in the reservoir (**page 44**).
- **Rear brake**— Check operation. Adjust free play, if necessary (**page 46**).
- **Tyres**—Check condition and pressure (**page 52**).
- **Clutch**—Check for smooth operation. Adjust free play if necessary (**page 39**).
- **Drive chain**—Check condition and slackness (**page 40**). Adjust and lubricate if necessary.
- **Throttle**—Check for smooth opening and closing in all steering positions (**page 40**).
- **Lamps and Horn**—Check that headlamp, tail/stop lamp, turn signal lamps and horn function properly.
- **Rear view mirror**—Ensure that the rear view mirror gives a good rear view when you are sitting on the vehicle.
- **i3s switch**—Make sure whether the i3s switch is in “ON” or “OFF” position (**page 16**).
- **i3s system**—Make sure that i3s system is functional properly (**page 16**).
- **Fitting & Fasteners**—Check & tighten if necessary.
- **Steering**—Check for smooth action for easy maneuverability.

- **Side stand indicator**—Make sure that the side stand is up. If it is kept down when ignition key is in “ON” position the side stand indicator (**page 18**) will glow on the speedometer panel.
- Confirm that the programmed FI malfunction indicator lamp (MIL) (2) glows continuously and then should go “OFF” once the engine is started.

STARTING THE ENGINE

Always follow the proper starting procedure described below :

- To protect the catalytic converter in your vehicle’s exhaust system, avoid extended idling and the use of leaded petrol.
- Your vehicle’s exhaust contains poisonous carbon monoxide gas. High levels of carbon monoxide can collect rapidly in enclosed areas such as garage. Do not run the engine with the garage door closed.

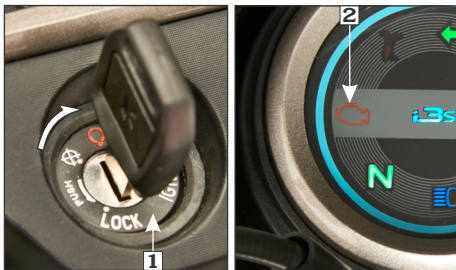

(1) Ignition switch

(2) Programmed FI malfunction indicator lamp (MIL)

! CAUTION

- *If electric starter switch is pressed continuously and engine does not start, cranking of engine will stop after 5 secs. After that rider again needs to press the electric starter switch.*
- *If engine started, cranking of the engine will stop after r/min reaches more than 1000 r/min under normal condition.*

NOTE

If MIL remains “ON” even if the vehicle is started, there is an abnormality in the programmed FI system. It is recommended to reduce the speed and drive to the Authorised Hero MotoCorp workshop for check-up.

Preparation

Before starting insert the key and follow the below mentioned procedure :

- Turn the ignition switch (1) to “ON” (Ⓞ) position.
- Find neutral position & check neutral (N) indicator (3) on instrument console with ignition “ON”.



(3) Neutral indicator

- Make sure whether the i3s switch (4) is in “ON” or “OFF” position.



(4) i3s switch

- **Electric start** : Press the electric starter switch with fully closed throttle.
- **Kick start** : Depress the kick starter until resistance is felt. Then let the kick starter return to the top of its stroke. Kick from the top of the stroke through to the bottom with a rapid, continuous motion.

Starting Procedure

At any ambient temperature, Press the starter switch with the throttle completely closed.

NOTE

- *If you plan to ride your vehicle at an altitude above 2000 meter, consult for advice at Authorised Hero MotoCorp workshop.*
- *While the vehicle is operated at an altitude above 2000 meter, you may not achieve sufficient engine performance. Please visit your Authorised Hero MotoCorp workshop.*
- *The engine will not start if the throttle is open because the Electronic control unit (ECU) cuts-off the fuel supply.*

Flooded engine

If the engine fails to start after repeated attempts, it may be flooded with excess fuel.

- Open the throttle fully.
- Press the starter switch for 5 seconds.
- Follow the normal starting procedure.
- If the engine starts with unstable idle, open the throttle slightly.
- If the engine does not start wait for 10 seconds, then follow first 3 steps again.

Ignition cut off

Your vehicle is designed to automatically stop the engine & fuel pump, if vehicle falls down.

(Bank angle sensor cuts off the ignition).

NOTE

If the vehicle has fallen down, before restarting the engine you must turn the ignition switch to “OFF” (⊗) position and then back to “ON” (○) position.

Running in

Help assure your vehicle's future reliability and performance by paying extra attention to how you ride during the first 500 km.

During this period, avoid full-throttle starts and rapid acceleration.



NOTE

- To start the engine if any gear is engaged, press the clutch lever and press the starter switch.
- Do not open the throttle during starting the vehicle.



WARNING

Never run the engine in a closed area, the exhaust contains poisonous gases.

RIDING

- After the engine has been warmed up, the vehicle is ready for riding.
- While the engine is idling, press the clutch lever and depress the gearshift pedal downwards using the toe to shift into 1st gear.
- Slowly release the clutch lever and at the same time, gradually increase engine speed by opening the throttle. Coordination of the throttle and clutch lever will assure a smooth positive start.
- When the vehicle attains a moderate speed, close the throttle, press the clutch lever and shift to 2nd gear by depressing the gearshift pedal.

- The sequence is repeated progressively to shift 3rd, 4th and 5th (top gear).

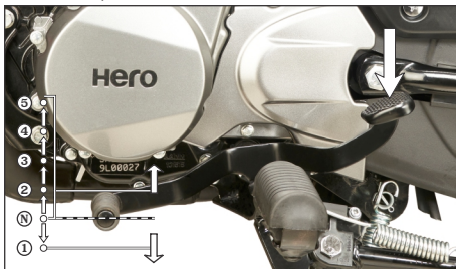

Recommended max. operating speed in each gear.

- 1st : 0-15 km/hr
- 2nd : 10-25 km/hr
- 3rd : 20-40 km/hr
- 4th : 25-50 km/hr
- 5th : 40 km/hr and above



CAUTION

Do not shift gears without operation of clutch and without closing the throttle otherwise this would lead to damage of gears.

BRAKING

- For normal braking, close the throttle and gradually apply both front and rear brakes simultaneously while shifting down gears to suit your road speed.
- For maximum deceleration/quick stopping, close the throttle and apply the front and rear brakes simultaneously.

For integrated braking system (IBS)

To stop the vehicle, press the rear brake pedal for the application of front and rear brakes simultaneously. However, for more effective braking, it is advised to apply front and rear brake simultaneously, keeping the throttle in closed position.

WARNING

- *When riding in wet or rainy conditions, or on loose surfaces, apply front brake carefully after applying rear brake to avoid wheel slip.*
- *Extreme braking may cause wheel locking and reduce control over the vehicle.*
- *Wherever possible, reduce speed or apply brake before entering a turn, closing the throttle or braking in mid turn may cause wheel slip. Wheel slip will reduce control over the vehicle.*
- *When riding in wet or rainy conditions, or on loose surfaces the ability to stop the vehicle reduces.*
- *All your actions should be smooth under these conditions. Sudden acceleration, braking or turning may cause loss of control. For your safety, exercise extreme caution when braking, accelerating or turning.*
- *When descending a long steep slope use engine braking (power) by changing to lower gears, with intermittent use of both brakes. Continuous brake application can overheat the brakes and reduce their effectiveness.*

PARKING

After stopping the vehicle, shift the transmission to neutral, turn the ignition switch “OFF” (⊗), park the vehicle on main stand, lock the steering and remove the key.

CAUTION

- *Park the vehicle on firm level ground to prevent overturning.*
- *While parking vehicle on side stand engage the first gear.*

TOOL KIT /FIRST AID KIT

The tool kit (1) is located below the seat in the rear. Some emergency repairs, minor adjustments and parts replacement can be performed with the tools contained in the kit.

Kit consists of following tool:

- Tool bag-1 No.
- +, - No. 2 Driver-1 No.
- Grip-1 No.
- Box wrench 16x14-1 No.
- Pin spanner-1 No.

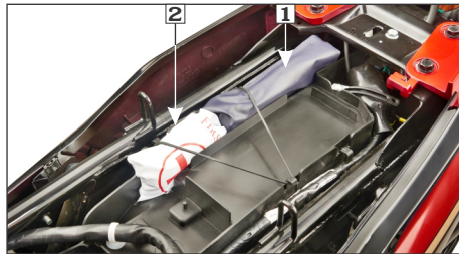

(1) Tool kit

(2) First aid kit

The first aid kit (2) is located below the seat in the rear. For some emergency first aid can be performed by medicine contained in the kit.

Kit contains the following items:

- Antiseptic cream- 1 No.
- Sterilized dressing- 1 No.
- Water proof plaster- 1 No.
- Elastic bandage- 1 No.
- Gauze (Rolled bandage)- 1 No.
- Sterilized elastic plaster- 1 No.
- First aid bag- 1 No.

CLEANING AND WASHING OF VEHICLE

Follow the below mentioned steps for washing the vehicle.

- Wet the vehicle with light water spray. Avoid directing water meter console, muffler outlets and electrical parts.
- Clean the headlamp lens and other plastic parts using a cloth or sponge dampened with a solution of mild detergent and water.
- Rub the soiled area gently rinsing it frequently with fresh water.
- After cleaning spray water thoroughly.
- Dry the vehicle by wiping with dry soft cloth.



NOTE

- ***Our authorised dealership take all above mentioned precautions like recommended detergents and usage of muffler caps/plugs during wash to ensure quality wash.***
- ***Do not use high pressure water (or air). It can damage certain parts of the vehicle.***

MAINTENANCE

Importance of maintenance

A well-maintained vehicle is essential for safe economical and trouble-free riding. It will also help reduce pollution.

To help you, take proper care of your vehicle, the following pages include a maintenance schedule and a maintenance record for regular scheduled maintenance.

These instructions are based on the assumption that the vehicle will be used exclusively for its designed purpose.

Sustained high speed operation or operation in unusually wet or dusty conditions will require more frequent service than specified in the maintenance schedule.

Consult your Authorised Hero MotoCorp Dealer for recommendation applicable to your individual needs and use. If your vehicle overturns or is involved in a crash, be sure that you visit your Authorised Hero MotoCorp workshop for detailed inspections.



WARNING

- ***Improperly maintaining this vehicle or failing to correct a problem before you ride can cause a crash in which you can be seriously hurt or killed.***
- ***Always follow the inspection and maintenance recommendations and schedules in this owner's manual.***

Maintenance safety

This section includes instructions on some important maintenance tasks. You can perform some of these tasks with the tools provided (if you have basic mechanical skills).

Other tasks that are more difficult and require special tool. It is recommended that wheel removal should normally be handled by a Hero MotoCorp authorised workshop.

You will come across some of the most important safety precautions in the following pages of this manual.

However, we cannot warn you of every conceivable hazard that can arise in performing maintenance. Only you can decide whether or not you should perform a given task.



WARNING

- ***Failure to follow maintenance instructions and precautions properly can seriously injure you.***
- ***Always follow the procedures and precautions in this owner's manual.***

SAFETY PRECAUTIONS

- Make sure the engine is “OFF” before you begin any maintenance or repair. This will help to eliminate several potential hazards:
 - **Carbon monoxide poisoning from engine exhaust.**
Be sure there is adequate ventilation whenever you operate the engine.
 - **Burns from hot parts.**
Let the engine and exhaust system cool before touching.
 - **Injury from moving parts.**
Do not run the engine unless instructed to do so.
- Read the instruction before you begin and make sure you have the tools and skills required.
- To help prevent the vehicle from falling over, park it on a firm, level surface on the main stand.
- To reduce the possibility of a fire or explosion, be careful when working around petrol or batteries. Use only nonflammable solvent, not petrol, to clean parts. Keep cigarettes, sparks and flames away from the battery and all fuel-related parts.

Remember that your Authorised Hero MotoCorp workshop knows your vehicle best and is fully equipped to maintain and repair it. To ensure best quality and reliability, it is recommended to use Hero MotoCorp genuine parts for repair and replacement.

MAINTENANCE SCHEDULE

Perform the pre-ride inspection (**page 21**) at each scheduled maintenance period.

I: INSPECT C: CLEAN R: REPLACE A: ADJUST O: OIL CHANGE
L: LUBRICATE T: TOP UP E: EMISSION CHECK

The following maintenance schedule specifies all maintenance required to keep your vehicle in peak operating condition. Maintenance work should be performed in accordance with standards and specifications of Hero MotoCorp by properly trained and equipped technicians. Your Authorised Hero MotoCorp workshop meets all of these requirements.

Ensure that each paid service is availed within **90 days** or **3000 km** from the date of previous service, whichever is earlier.

- ∨ To be serviced by your Authorised Hero MotoCorp workshop unless the owner has the relevant tools, technical information and is technically qualified.
- ✗ In the interest of safety, we recommend that these jobs are carried out only by your Authorised Hero MotoCorp workshop.

Note-1 : At higher odometer readings, repeat the frequency interval established here.

Note-2 : Replace air cleaner element once in every **15000 km** or early replacement may be required when riding in dusty areas.

Note-3 : Replace engine oil once in every **6000 km**. Top up once in every **3000 km**.

Note-4 : Visit Authorised Hero MotoCorp workshop for inspection, cleaning, lubrication and adjustment of drive chain at every **2000 km**.

Note-5 : Replace brake fluid once in a every **2 years** or **30000 km**, whichever is earlier.

Note-6 : Inspect & maintain specified torque.

Note-7 : Inspect the bearings free play, replace if necessary.

Note-8 : Replace front fork oil once in a every **2 years** or **30000 km**, whichever is earlier.

Note-9 : Inspect for any play in the rear suspension mounting bushes, replace if necessary.

Note-10 : Check CO emission at idle.

Note-11 : Inspect the canister hoses for deterioration, damage or loose connections and canister for cracks or other damages.

Note: Always wipe the water from the vehicle after washing. Use clean soft cloth or pressurized air for completely drying the water.













or Scan QR code

MAINTENANCE SCHEDULE

Dear Customer,

We would strongly recommend the following schedule, to keep your vehicle in perfect running condition and healthy environment. Vehicle subjected to severe use or ridden in dusty area will require more frequent servicing.

ITEMS	WHICHEVER COMES FIRST	DURING FREE SERVICE PERIOD					AFTER FREE SERVICE ONCE IN EVERY					
	SERVICE	1 st	2 nd	3 rd	4 th	5 th						
	DAYS	1st 60	Next 100	Next 100	Next 100	Next 100						
	KM Note-1	500-750	3000-3500	6000-6500	9000-9500	12000-12500	3000	6000	9000	12000	15000	
Fuel Line		I	I	I	I	I	I					
⚙️ Throttle Operation		I, A	I, A	I, A	I, A	I, A	I, A					
⚙️ Engine Idle Speed		I	I	I	I	I	I					
Air Cleaner Element	Note-2	Do not open air cleaner element unless there is a drivability problem					R					
Spark Plug		I, C, A	I, C, A	I, C, A	I, C, A	R	I, C, A				R	
⚙️ Valve Clearance		I, A	I, A	I, A	I, A	I, A	I, A					
Engine Oil	Note-3	O	I, T	O	I, T	O	I, T	O				
⚙️ Engine Oil Strainer Screen		C		C		C		C			C	
⚙️ Engine Oil Filter		I		I		R		I			R	
Electric Starter		I	I	I	I	I	I					
Oil Circulation		I	I	I	I	I	I					
⚙️ Drive Chain	Note-4	I,C,L,A at every 2000 km					I,C,L,A at every 2000 km					
Drive Chain Slider			I	I	I	I	I					
Battery Voltage		I	I	I	I	I	I					
Brake Shoe		I, A	I, A	I, A	I, A	I, A	I, A					

ITEMS	WHICHEVER COMES FIRST	DURING FREE SERVICE PERIOD					AFTER FREE SERVICE ONCE IN EVERY					
	SERVICE	1 st	2 nd	3 rd	4 th	5 th						
	DAYS	1st 60	Next 100	Next 100	Next 100	Next 100						
	KM Note-1	500-750	3000-3500	6000-6500	9000-9500	12000-12500	3000	6000	9000	12000	15000	
	Disc Wear/Pad Wear	I	I	I	I	I	I					
	Brake Fluid	Note-5	I, T	I, T	I, T	I, T	I, T	I, T				
	Brake System (Brake Cam & Brake Pedal)		C, L		C, L		C, L		C, L			
	Stop Lamp Switch		I, A	I, A	I, A	I, A	I, A	I, A				
	Headlamp Focus		I, A	I, A	I, A	I, A	I, A	I, A				
	Clutch Lever Free Play		I, A	I, A	I, A	I, A	I, A	I, A				
	Side Stand Pivot Bolt		C, L	C, L	C, L	C, L	C, L	C, L				
	Rear Brake Pedal/ Main Stand Pivot		C, L	C, L	C, L	C, L	C, L	C, L				
	Side Stand Switch		I, C	I, C	I, C	I, C	I, C	I, C				
	i3s System		I	I	I	I	I	I				
	Nut, Bolts & Fasteners	Note-6	I	I	I	I	I	I				
	Wheel Bearings	Note-7	I	I	I	I	I	I				
	Wheels/Tyres		I	I	I	I	I	I				
	Steering Head Bearing		I	I, A	I	I, A	I, L, A	I	I, A		I, L, A	
	Front Suspension/Oil	Note-8	I	I	I	I	I	I				
	Rear Suspension	Note-9	I	I	I	I	I	I				
	Muffler (Catalytic Converter)	Note-10			I, E		I, E		I, E			
	Evaporative Emission Control System	Note-11	I	I	I	I	I	I				

SPARK PLUG INSPECTION

Recommended spark plugs:

NGK-CPR 7EA9, RG8YC (Federal Mogul)

For most riding conditions this spark plug heat range number is satisfactory. However, if the vehicle is going to be operated for extended periods at high speeds or near maximum power in hot climates, the spark plug should be changed to a cold heat range number, consult Authorised Hero MotoCorp workshop on this if required.

- Clean any dirt around the spark plug base.
- Disconnect the noise suppressor cap (1) and remove the spark plug (2) with the help of spark plug box wrench provided in the tool bag.

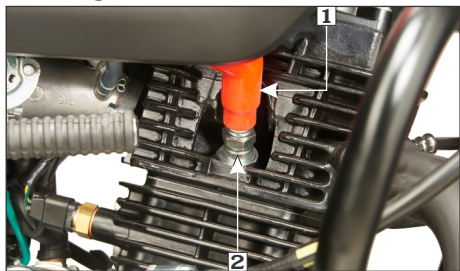

(1) Noise suppressor cap

(2) Spark plug

- Visually inspect the spark plug electrodes for wear. The center electrode should have square edges and the side electrode should not be eroded. Discard the spark plug if there is apparent wear or if the insulator is cracked or chipped.

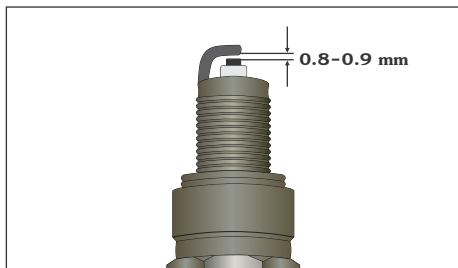

- Make sure that the spark plug gap is **0.8-0.9 mm** using a wire-type feeler gauge. If adjustment is necessary, bend the side electrode carefully. Make sure the plug washer is in good conditions.
- With the plug washer attached, thread the spark plug in by hand to prevent cross-threading.
- Tighten a new spark plug 1/2 turn with spark plug wrench to compress the washer. If you are reusing a plug, it should only take 1/8-1/4 turn after the plug seats.

! CAUTION

- *Do not remove the spark plug and test for spark on the vehicle by cranking the engine as this could lead to fire or explosion*
- *Install a dummy spark plug in the cylinder head and test for spark.*
- *Never use a spark plug with improper heat range.*
- *Always use resistor type spark plug.*

ENGINE OIL

Use hero genuine engine oil or recommended grade oil.

BRAND: Hero 4T plus

GRADE: SAE 10W 30 SL Grade

(JASO MA2).

Manufactured by:

- Tide Water Oil Co. (India) Ltd.
- Savita Oil Technologies Limited.
- Bharat Petroleum Corporation Limited.

**OIL CAPACITY: 0.95 litre (disassembly)
: 0.75 litre (at oil change)**

Engine oil level inspection/Top up process

Check engine oil level each day before operating the vehicle. The oil level dipstick (1) is on the right crankcase cover for measuring oil level. Oil level must be maintained between the upper (2) and lower (3) level marks on the oil level dipstick.

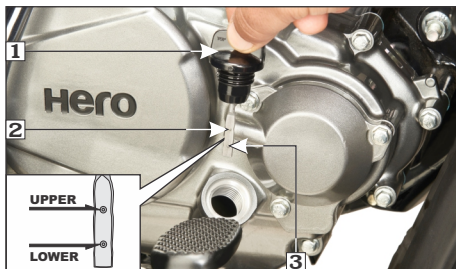

(1) Oil level dipstick (2) Upper level mark
(3) Lower level mark

Do top up if oil level reaches towards the lower level mark or every 3000 km whichever is earlier.

- Park the vehicle on its main stand.
- Turn the i3s switch to “OFF” position.
- Start the engine & let it idle for 3–5 minutes.
- Slightly loosen the engine oil check bolt (4) and check the engine oil entry into the cylinder head.

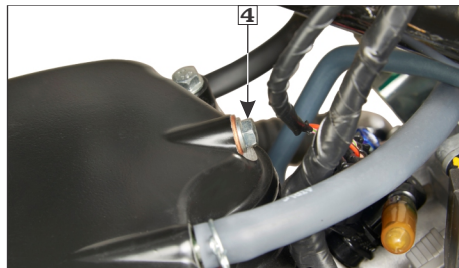

(4) Engine oil check bolt

- After checking the oil circulation, tighten the engine oil check bolt.
- Stop the engine and wait for 2–3 minutes.
- Remove the oil level dipstick, wipe it clean and insert without screwing it in.
- Remove the oil level dipstick and check the oil level.
- If required, add the specified oil up to the upper level mark. Do not overfill.

- Quantity of oil to be filled is **0.75 liters** (approx.) during oil change when right crankcase cover is not removed.
- Reinstall the oil level dipstick and check for oil leaks.



NOTE

The engine will stall if the i3s switch is in “ON” position during warmup.

Engine oil replacement process/ Oil circulation inspection

Drain engine oil with the engine warm and the vehicle on its main stand.

- To drain the oil, remove the oil level dipstick (page-32) and drain bolt (1) with sealing washer (2).
- After the oil has completely drained, reinstall the drain bolt with a new sealing washer.

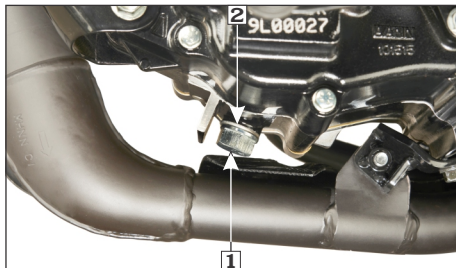

(1) Drain bolt

(2) Sealing washer

- Fill the crankcase through the oil filler hole with **0.75 litre** (approximately) of the recommended grade oil.
- Reinstall the oil level dipstick with a new O-ring.
- Start the engine and allow it to idle for few minutes.
- Stop the engine, let the engine oil settle down and recheck the oil level.
- Make sure that oil level is at the “UPPER” level mark of the oil level dipstick with the vehicle in an upright position and that there are no oil leaks.



CAUTION

- *Running the engine with insufficient oil can cause serious engine damage.*
- *Running the engine with excessive oil can cause spark plug fouling & loss in performance.*
- *Engine oil is a major factor affecting the performance and service life of the engine. Non-detergent, vegetable or castor based racing oils are not recommended.*

ENGINE OIL FILTER ELEMENT



NOTE

Drain the engine oil thoroughly (page 33) in case of engine oil filter element replacement.

- Remove the three mounting bolts (1).
- Remove the engine oil filter element cover (2) with O-ring (3).

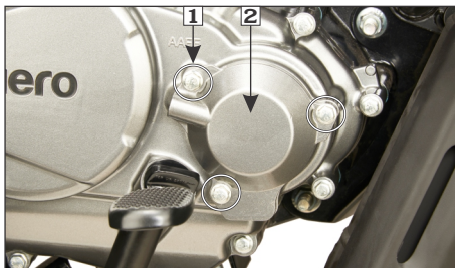

(1) Mounting bolts
(2) Engine oil filter element cover

- Remove the engine oil filter element (4) from the cover.

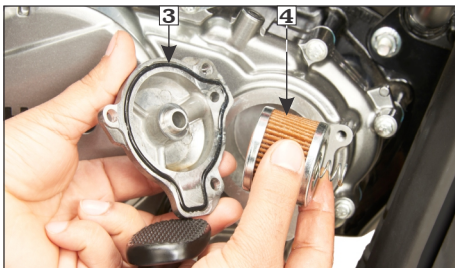

(3) O-ring (4) Engine oil filter element

- Replace the engine oil filter element (4).

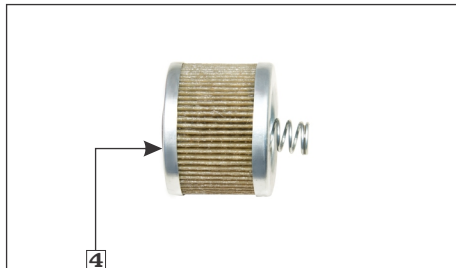

(4) Engine oil filter element

NOTE

- When the engine oil filter element replaced always replace the O-ring with the new one.*
- Make sure that O-ring is properly seated.*
- Apply engine oil on engine oil filter element before installation.*
- Inspect and replace engine oil filter element as specified in the maintenance schedule.*

- Installation is in the reverse order of removal.

OIL FILTER SCREEN

- Drain the engine oil thoroughly (**page 33**).
- Remove the side stand switch screw (1).
- Disconnect the clutch cable (2).
- Remove the exhaust muffler (3), rider footrest assembly with side stand (4), kick starter pedal (5) and right crankcase cover (6).

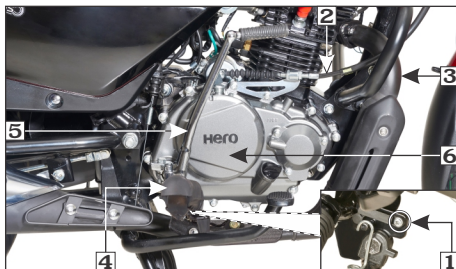

- (1) Side stand switch screw
 (2) Clutch cable (3) Exhaust muffler
 (4) Rider footrest assembly with side stand
 (5) Kick starter pedal (6) Right crankcase cover

- Remove the gasket (7) and dowel pins (8).
- Remove the oil filter screen (9) and wash it in clean non flammable or high flash point solvent (kerosene).

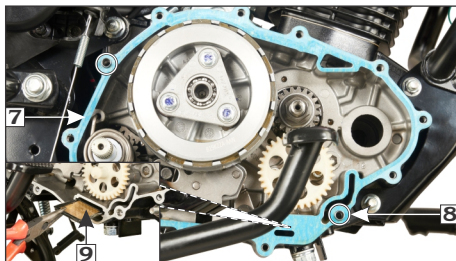

- (7) Gasket (8) Dowel pins
 (9) Oil filter screen

- Reinstall the oil filter screen with the sharp edged side facing inwards.
- Reinstall the dowel pins, new gasket, crankcase cover, kick starter pedal, rider footrest assembly with side stand, exhaust muffler and clutch cable.
- Install the side stand switch screw.
- Adjust the clutch cable free play, if required (**page 39**).
- Fill the crankcase with clean engine oil as per specification.

NOTE

Ensure to replace gasket with new one once removed.

AIR CLEANER

Air cleaner element inspection

The air cleaner is viscous paper pleated type filter which has enhances filtering efficiency. The air cleaner should be replaced at regular intervals (**page 28**). When riding in dusty areas, more frequent replacement may be necessary.

- Remove the seat (**page 19**).
- Remove the air cleaner cover screws (1) and the cover (2).

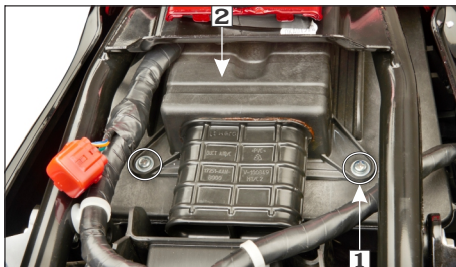

(1) Air cleaner cover screws **(2) Cover**

- Remove the air cleaner element (3).

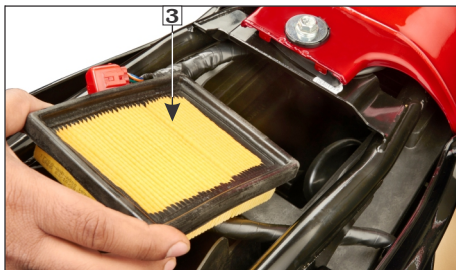

(3) Air cleaner element

! CAUTION

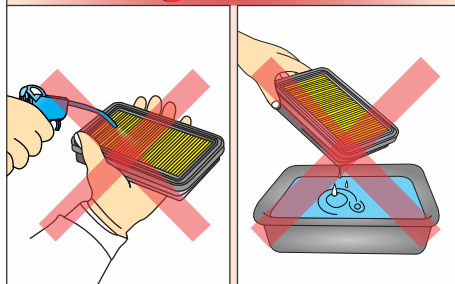

- *Never wash or clean the wet, paper pleated type filter. Replace filter element once in every 15000 km.*
- *Replace it earlier if it becomes very dirty, damage on surface or on the sealing area.*

NOTE

Align the tabs of air cleaner cover before installing screws & the cover.

- Clean the air cleaner housing using a shop towel.
- Install the new air cleaner element.
- Install the air cleaner element cover.
- Install the seat (**page 19**).

Air cleaner drain tube plug cleaning

Remove the drain tube (1) and drain the deposit into a container.

Follow the above process more frequently when riding in rain or at full throttle.

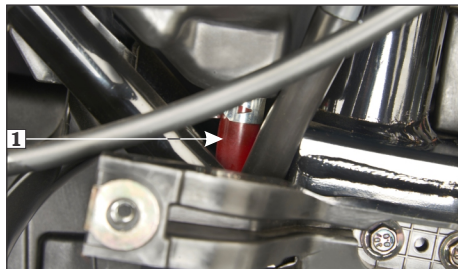

(1) Drain tube

VALVE CLEARANCE ADJUSTMENT

Excessive valve clearance will cause noise, and little or no clearance will prevent the valve from closing and cause valve damage and power loss. Check valve clearance at the specified intervals (page 28).

NOTE

The checking or adjusting of valve clearance should be performed while the engine is cold. The clearance will change as the engine temperature rises.

- Remove the fuel tank.
- Remove the cylinder head left side cover (1) with its gasket (2) by removing bolts (3).

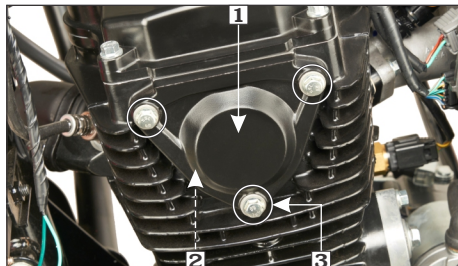

- (1) Cylinder head left side cover
- (2) Cylinder head left side cover gasket
- (3) Cylinder head left side cover bolts

- Remove the engine breather pipe (4) by removing the clip (5).
- Remove the cylinder head cover (6) with its gasket (7) by removing the cylinder head cover bolts (8).

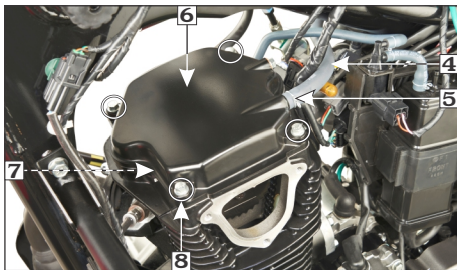

- (4) Engine breather pipe
- (5) Clip
- (6) Cylinder head cover (7) Gasket (8) Bolts

- Remove the timing hole cap with O-ring (9). Rotate the cam sprocket (12) clockwise using the special tool (13) until the 'T' mark (10) on the flywheel coincides with the index mark (11) on the left crankcase cover. In this position, the piston will either be on the compression or exhaust stroke.

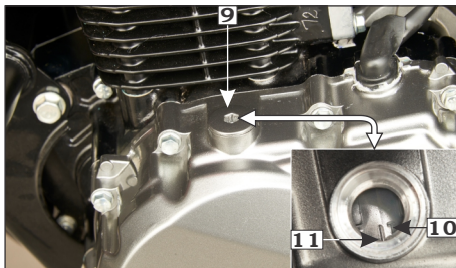

(9) Timing hole cap
(11) Index mark

(10) 'T' mark

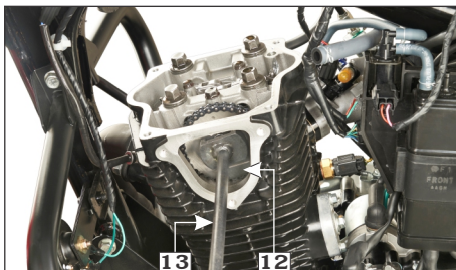

(12) Cam sprocket

(13) Special tool

The adjustment must be made when the piston is at top dead center and both the inlet and exhaust valves are closed.

This condition can be determined by moving the rocker arms. If they are free, it is an indication that the valves are closed and the piston is in compression stroke. If they are tight, the valves are open, rotate the cam sprocket 360° clockwise and realign the 'T' mark with the index mark.

- Check the clearance by inserting the feeler gauge (14) between the adjusting screw (15) and valve stem (16).

Standard clearance (cold condition)

Intake : 0.08 mm

Exhaust : 0.12 mm

NOTE

Before inserting the feeler gauge, smear a bit of engine oil on the feeler gauge to avoid damage to the feeler gauge.

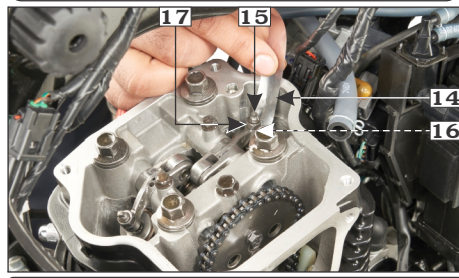

(14) Feeler gauge

(15) Adjusting screw

(16) Valve stem

(17) Lock nut

- Adjust by loosening the lock nut (17) and turning the adjusting screw until there is a slight drag on the feeler gauge.
- After tightening the lock nut, check again the clearance.
- Install all parts in the reverse order of disassembly.
- To adjust the free play, loosen the lock nut (3). Turn the adjusting nut (4) to obtain the specified free play. Tighten the lock nut and check the adjustment.



NOTE

All O-rings and gaskets to be replaced with new ones.

CLUTCH LEVER FREE PLAY

Adjustment

Clutch adjustment may be required if the vehicle stalls when shifting into gear or tends to creep or if the clutch slips, causing acceleration to lag behind engine speed.

Normal clutch lever free play (1) is 10–20 mm at the lever (2).

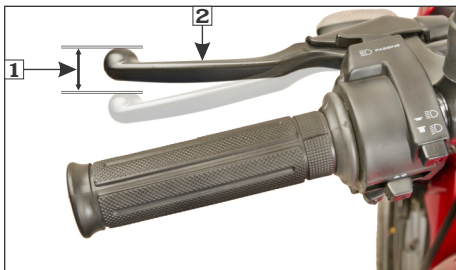

(1) Free play: 10–20 mm (2) Clutch lever

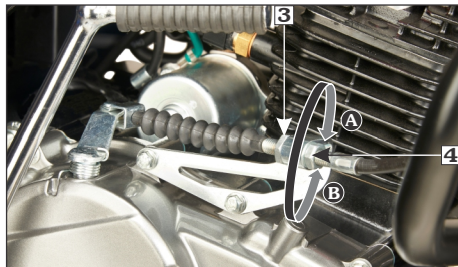

(3) Lock nut (4) Clutch cable adjusting nut (A) Decrease free play (B) Increase free play

- Start the engine, press the clutch lever and shift into gear. Make sure the engine does not stall, and vehicle does not creep. Gradually release the clutch lever and open the throttle. The vehicle should start smoothly and accelerate.

Other checks

- Check the clutch cable for kinks or signs of wear that could cause sticking or failure.
- Check for clutch cable model. Use genuine clutch cables.
- Check for clutch cable routing.



NOTE

If proper adjustment cannot be obtained or the clutch does not work correctly, visit your Authorised Hero MotoCorp workshop.

THROTTLE OPERATION

Cable inspection

Check for smooth rotation of the throttle grip from the fully open to the fully closed position. Check at full left and full right steering positions. Inspect the condition of the throttle cable from the throttle grip down to the throttle body. If the cable is kinked, chafed or improperly routed, it should be replaced or rerouted. Standard throttle grip free play (1) is approximately 2–6 mm of grip rotation.

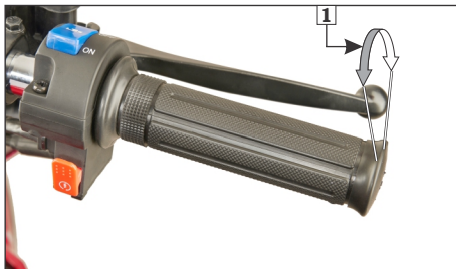

(1) Free play: 2–6 mm

Free play adjustment

Slide the boot (2), loosen the lock nut (3) and turn the adjuster (4).

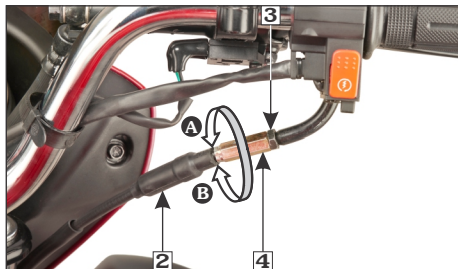

(2) Boot (3) Lock nut (4) Adjuster
(A) Decrease free play (B) Increase free play

DRIVE CHAIN SLACKNESS

The service life of the drive chain depends upon proper lubrication and adjustment.

Poor maintenance can cause premature wear or damage to the drive chain and sprockets.

The drive chain (1) should be checked and lubricated as part of the pre-ride inspection (**page 21**). Under severe usage, or when the vehicle is ridden in unusually dusty areas, more frequent maintenance will be necessary.

Inspection

- Turn the engine “OFF”, park the vehicle on its main stand and shift the transmission to neutral. Remove hole cap (2).
- Drive chain slack (3) should be adjusted to allow approximately 30 mm vertical movement by hand.

Adjustment

- Park the vehicle on its main stand with the transmission in neutral and the ignition switch in “OFF” (⊘) position.
- Remove the exhaust muffler.
- Loosen the rear axle nut (1) and sleeve nut (2). Loosen both the drive chain lock nuts (3).
- Turn both the adjusting nuts (4) in an equal number of turns until the correct drive chain slack is obtained. Turn the adjusting nut clockwise to decrease the slack or anticlockwise to increase the slack of the chain.

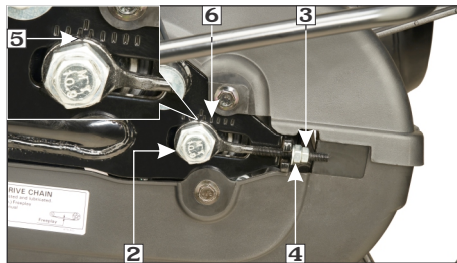

(2) Sleeve nut (3) Drive chain lock nut
(4) Drive chain adjusting nut (5) Index mark
(6) Scale graduation

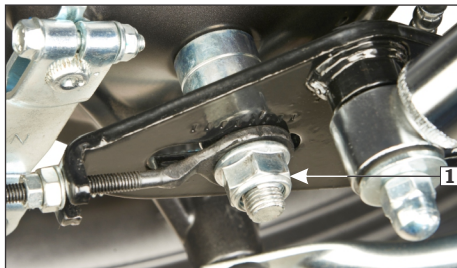

(1) Rear axle nut

- Align the chain adjuster index mark (5) with the corresponding scale graduations (6) on both the sides of the swing arm equally.

- If the drive chain slack is excessive when the rear axle is moved to the farthest limit of adjustment, the drive chain is worn and must be replaced. Tighten the rear axle nut and sleeve nut.

- **Rear axle nut torque: 5.2 kgf-m.**
- **Sleeve nut torque: 4.2 kgf-m.**

- Check the drive chain slack again.
- Install the exhaust muffler.
- Rear brake pedal free play and stop lamp switch free play are affected when repositioning the rear wheel to adjust drive chain slack. Check rear brake pedal free play and adjust as necessary (**page 46**).

Lubrication

- Turn the engine “OFF”, park the vehicle on its main stand and shift the transmission into neutral.

- Lubricate the drive chain by applying liberal amount of SAE#90 oil.

! CAUTION

Regular adjustment and lubrication as per the maintenance schedule would ensure high performance and longer life.



NOTE

Visit Authorised Hero MotoCorp workshop for inspection, cleaning, lubrication and adjustment of drive chain at every 2000 km.

DRIVE CHAIN SLIDER INSPECTION

(Refer to “Maintenance Schedule” on **(page 28)**).

Check the drive chain slider (1) for wear, the chain slider must be replaced if it is worn to the bottom of the cutout or wear limit (2) is reached. For replacement, visit your Authorised Hero MotoCorp workshop.

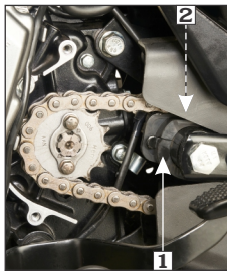

(1) Drive chain slider

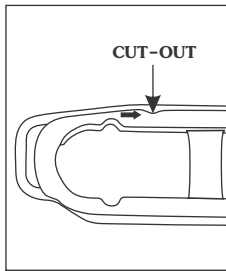

(2) Wear limit

BRAKES

Brakes (Integrated braking system)

Brakes are items of personal safety and should always be maintained with proper adjustments.

When one applies the Integrated/Rear brake pedal, front & rear brakes activate jointly.

(a) Front brake inspection (Disc type)

Master Cylinder/Reservoir.

Location: Right handlebar.

Brake fluid recommended: DoT 3 or DoT 4
 Fluid level–Ensure that the brake fluid level does not fall below “MIN” mark (1) on the master cylinder, when checked with the master cylinder parallel to the ground. The level decreases gradually due to piston movement to compensate pad wear. If the level decreases abruptly, check for leakage in the brake system and contact your Authorised Hero MotoCorp workshop.

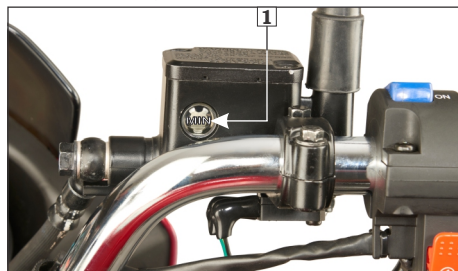

(1) "MIN" mark

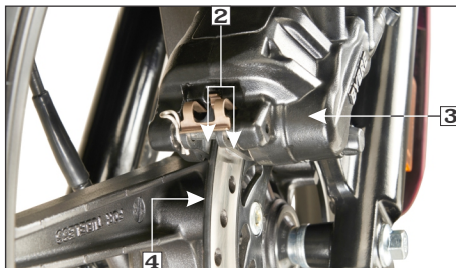

(2) Brake pads (3) Caliper (4) Disc



NOTE

- Clean the dirt and mud accumulation between the brake pads (2), caliper (3) and the disc (4) by using a water jet.
- Always contact your Authorised Hero MoroCorp workshop for refilling of master cylinder when necessary. Do not mix DoT 3 and DoT 4 brake fluid.

(b) Rear brake fluid (Disc variant)

Refer to the safety precautions on (page 27). Reservoir (1)

Location : Near the right side pillion footrest.

Brake fluid recommended :

DoT-4/DoT-3.

Fluid level – Ensure that the brake fluid level does not fall below "MIN" mark (2) on the reservoir parallel to the ground. The level decreases gradually due to piston movement to compensate pad wear. If the level decreases

abruptly, check for the leakages in the brake system and consult your Authorised Hero MoroCorp workshop.

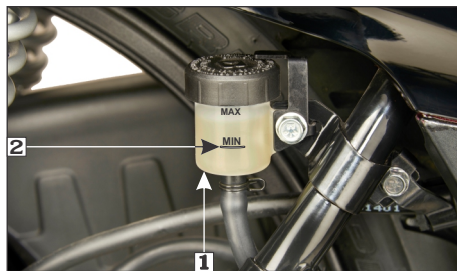

(1) Reservoir (2) "MIN" mark

(c) Brake pad wear (Disc variant)

Brake pad wear depends upon the severity of usage, the type of riding & road conditions. Generally, the pads will wear faster on wet & dirty roads. Inspect the pads at each regular maintenance interval.

Inspection

- Check the wear indicator grooves (1) on each pad.
- Check the brake pads for wear by examining the wear limit grooves on each pad.
- Replace the pads if worn out to the bottom of the groove.
- Always replace both the pads as a set.
- Visit your Authorised Hero MoroCorp workshop for the brake pad replacement.

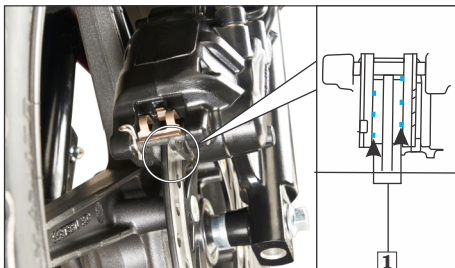

(1) Wear indicator groove

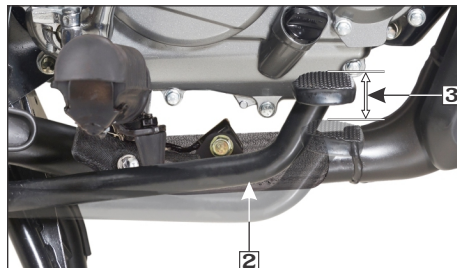

(2) Integrated/Rear brake pedal

(3) Free play: 20-30 mm

! WARNING

Always apply front and rear brakes simultaneously to avoid skidding of vehicle.

(d) Front brake inspection (Drum variant)

The distance, the front brake lever (1) and integrated brake pedal (2) moves before each brake starts to engage is called free play (3).

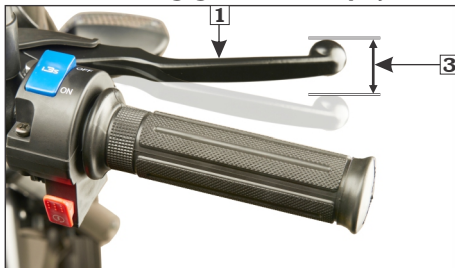

(1) Front brake lever

(3) Free play: 10-20 mm

Front brake cable (A) on “F” side Adjustment

- Push the integrated brake arm (4) by hand in the direction as shown.
- Turn the first adjuster nut (5) till you cannot turn it by hand.

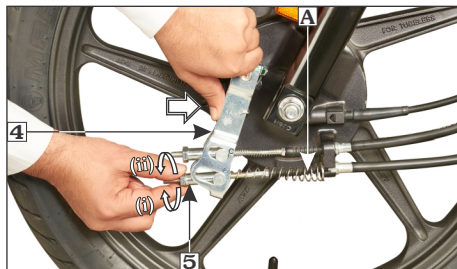

(4) Integrated brake arm (5) First adjuster nut

(i) Decrease free play (ii) Increase free play

- Check the free play of front brake lever.
FREE PLAY: 10-20 mm
- If the free play is out specification turn the adjuster nut to obtain desired free play.

Integrated brake cable (B) on “C” side Adjustment

- Push the integrated brake arm (4) by hand in the direction as shown.
- Turn the second adjuster nut (6) until a gap is created between joint (7) and the slot on the first side in integrated brake arm.
- After ensuring the gap, turn the second adjuster nut counterclockwise by half rotation.
- Check the free play of rear brake pedal.
FREE PLAY: 20-30 mm
- If the free play is out specification turn the adjuster nut to obtain desired free play.

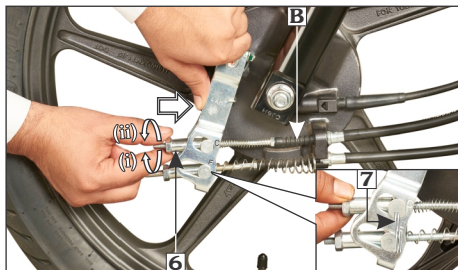

(6) Second adjuster nut
(i) Decrease free play (ii) Increase free play (7) Joint



NOTE

“F” & “C” is marked on integrated brake arm.

(e) Rear brake inspection Adjustment

- Park the vehicle on its main stand.
- Measure the brake pedal (1) free play before the brake starts to take hold.
Free play (2) should be 20-30 mm.

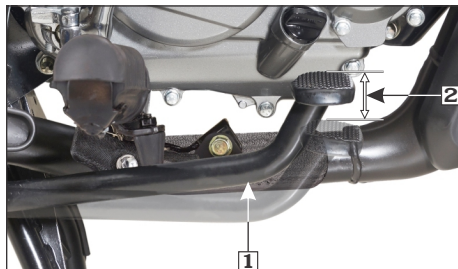

(1) Rear brake pedal
(2) Free play: 20-30 mm

- If adjustment is necessary, turn the rear brake adjusting nut (3).
- Make sure that the cut-out on the adjusting nut is seated on the brake joint pin (4) after the final adjustment has been made.
- Apply the brake several times and check for free wheel rotation when released.

CW- Clockwise, ACW- Anticlockwise

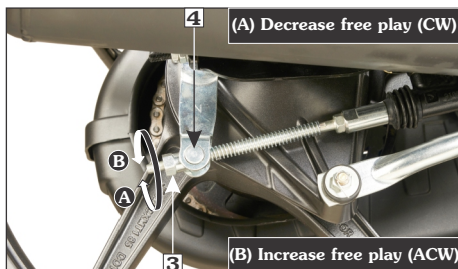

(3) Adjusting nut (4) Brake joint pin

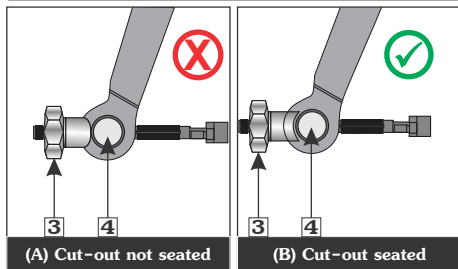

(3) Adjusting nut (4) Brake joint pin

NOTE

If proper adjustment cannot be obtained by this method, visit your Authorised Hero MotoCorp workshop.

(f) Brake wear indicators

When the brake is applied, an arrow (1), fixed to the brake arm (2), moves towards a reference mark (3) on the brake panel (4).

If the arrow aligns with the reference mark on full application of the brake, the brake shoes must be replaced.

Front brake wear indication (Drum variant)

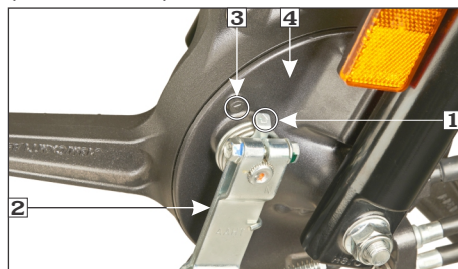

(1) Arrow (2) Brake arm
(3) Reference mark (4) Brake panel

Rear brake wear indication

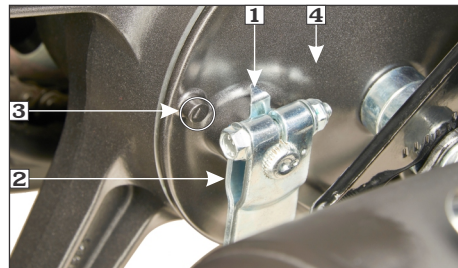

(1) Arrow (2) Brake arm
(3) Reference mark (4) Brake panel

SUSPENSION

Front and rear suspension inspection

- Check the front forks by locking the front brake and pumping the front fork up and down vigorously. The suspension action should be smooth and there should be no oil leakage.



- Check the rear shock absorber by pushing hard downwards on rear grip while the vehicle is not parked on stand. The suspension action should be smooth and there should be no oil leakage.

Rear shock absorber adjustment

Rear shock absorber adjustment can be made in any position from 1st to 5th according to the load/road conditions or owner's requirement.

Recommend adjustment

- Solo rider: 2nd position
- Rider + Pillion: 5th position

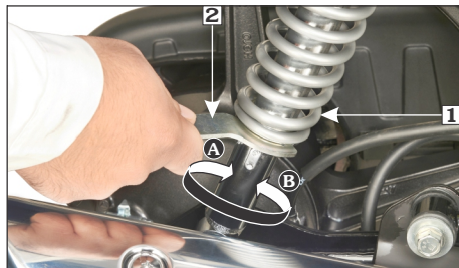

(1) Rear shock absorber (2) Pin spanner
(A) Stiffer (B) Softer

- In direction A: Stiffer
- In direction B: Softer

NOTE

Always adjust both the rear shock absorbers to the same position. To adjust the rear shock absorber (1), use the rear shock absorber adjustment tool (Pin spanner) (2) available in the tool kit.

WHEEL

(a) Front wheel (Disc variant)

Removal

- Support the vehicle securely on the main stand and raise the front wheel off the ground.
- Remove the speedometer cable (1) by pressing the tab (2) & pulling cable out from the speedometer gear (3).
- Remove the front axle nut (4).
- Remove the axle (5) and the wheel (6).

- Remove the side collar (7) from the right side of the wheel hub.
 - Remove the speedometer gear from the left side of the wheel hub.
- ÿ Tighten the front axle nut to the specified torque.

TORQUE : 5.2 kgf-m

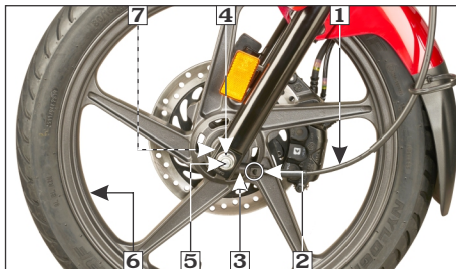

- | | |
|-----------------------|--------------|
| (1) Speedometer cable | (2) Tab |
| (3) Speedometer gear | (4) Axle nut |
| (5) Axle | (6) Wheel |
| (7) Side collar | |

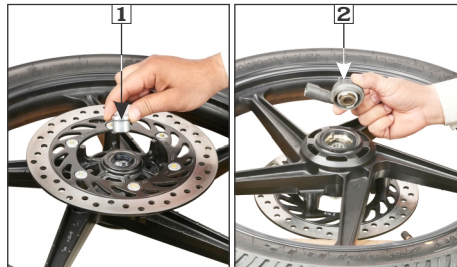

(1) Side collar (2) Speedometer gear

- After installing the wheel apply the brake several times and then check if the wheel rotates freely. Recheck the wheel if the brake drags or if the wheel does not rotate freely.

! CAUTION

Do not operate front brake lever when the wheel is removed.

Installation

- Install the side collar (1) to the right side of the wheel hub and then install the speedometer gear (2) on the left side of the wheel hub.
- Position the front wheel between the fork legs by aligning the slot on the speedometer gear with the lug on the fork leg and the disc between the brake pads to avoid damage to the pads. Insert the axle from the right side through the fork legs and wheel hub.

(b) Front wheel (Drum variant)

Removal

- Support the vehicle securely on the main stand and raise the front wheel off the ground.
- Remove the speedometer cable (1) by pressing the tab (2) & pulling cable out from the speedometer gear box.

- Disconnect the front brake cable (3) and integrated brake cable (4) from the integrated brake arm (5) and brake panel (6) by removing the front brake adjusting nut (7) and integrated brake adjusting nut (8).
- Remove the axle nut (9).
- Remove the axle (10) and wheel (11).
- Remove the side collar (12) from the right side of the wheel hub.

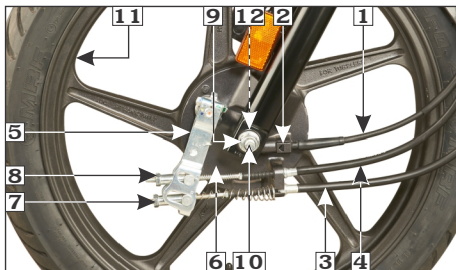

- (1) Speedometer cable (2) Tab
 (3) Front brake cable (4) Integrated brake cable
 (5) Brake arm (6) Brake panel
 (7) Front brake adjusting nut
 (8) Integrated brake adjusting nut (9) Axle nut
 (10) Axle (11) Wheel (12) Side collar

Installation

- Reverse the removal procedure.
- Install the front wheel by ensuring that the lug (13) on the left fork is located in the slot (14) in the brake panel.

- Tighten the axle nut.

Axle nut torque: 5.2 kgf-m

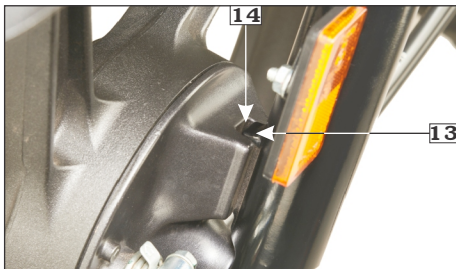

(13) Lug

(14) Slot

- Adjust the front brake free play and integrated brake free play (**page 45**).
- After installing wheel, apply the brake several times and check for free wheel rotation when released.

(c) Rear wheel

Removal

- Support the vehicle securely on the main stand and raise the rear wheel off the ground.
- Remove the exhaust muffler.
- Remove the rear brake adjusting nut (1) and disconnect the brake rod (2) from the brake arm (3) by pushing down the brake pedal. Disconnect the brake stopper arm (4) from the brake panel (5) by removing split pin (6), lock nut (7) and washer (8).

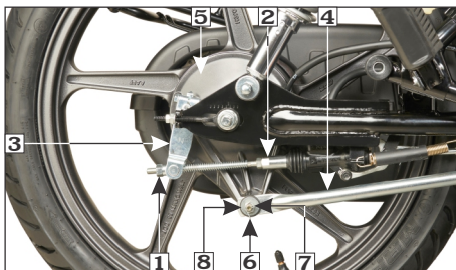

(1) Rear brake adjusting nut (2) Brake rod
 (3) Brake arm (4) Brake stopper arm
 (5) Brake panel (6) Split pin (7) Lock nut
 (8) Washer

- Remove the rear axle nut (9).
- Pull out the axle (10) and collar (11).
- Remove the wheel.

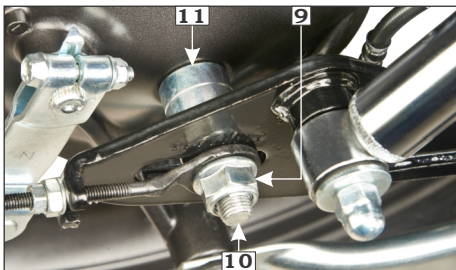

(9) Axle nut (10) Axle (11) Collar

Installation

- Reverse the removal procedure.
- Axle nut torque: 5.2 kgf-m**

Brake stopper arm nut torque: 2.2 kgf-m

- Adjust the rear brake free play (**page 46**) and drive chain slackness (**page 40**).
- After installing the wheel, apply the brake several times and check for free wheel rotation when released.

! CAUTION

Always replace used split pins with new ones.

MAIN/SIDE STAND LUBRICATION

- Park the vehicle on the level surface.
- Check the main/side stand return spring for damage or loss of tension.
- Check the main stand (1)/side stand (2) for freedom of movement.
- Clean and lubricate the side stand pivot bolt (3) and rear brake pedal/main stand pivot (4).
- Make sure the side/main stand is not bent.

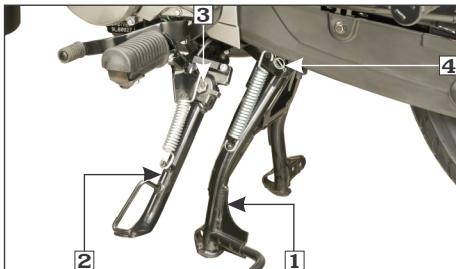

(1) Main stand (2) Side stand
 (3) Side stand pivot bolt
 (4) Rear brake pedal/Main stand pivot

TUBELESS TYRES

The tyres fitted on your vehicle are of TUBELESS type.

To safely operate your vehicle, your tyres must be of the proper type and size, in good condition with adequate tread, and correctly inflated for the load you are carrying.

The following pages give more detailed information on how and when to check the air pressure, how to inspect your tyres for damage, and what to do when your tyres need to be repaired or replaced.

Front	80/100-18 47P (Tubeless tyre)
Rear	90/90-18 51P (Tubeless tyre)

WARNING

- **Using tyres that are excessively worn or improperly inflated can cause a crash in which you can be seriously hurt or killed.**
- **Follow all instructions in this owner's manual regarding tyres inflation and maintenance.**

Air pressure

Keeping your tyres properly inflated provides the best combination of handling, tread life and riding comfort.

Generally, under-inflated tyres wear unevenly, adversely affect handling and are more likely to fail from being overheated.

Under inflated tyres can also cause wheel damage in rocky terrain.

Over-inflated tyres make your vehicle ride harshly, are more prone to damage from road hazards, and wear unevenly.

We recommend that you visually check your tyres before every ride and use a gauge to measure air pressure at least once a month or any time you think the tyres pressure might be low. Tubeless tyres have some self-sealing ability if they are punctured. However, because leakage is often very slow, you should look closely for punctures whenever a tyre is not fully inflated.

Always check air pressure when your tyres are "cold"—when the vehicle has been parked for at least three hours. If you check air pressure when your tyres are "warm"—when the vehicle has been ridden for even a few km—the readings will be higher than if the tyres were "cold". This is normal, so do not let air out of the tyres to match the recommended cold air pressures given below. If you do, the tyres will be under-inflated.

The recommended "cold" tyre pressures are:

	Rider only	Rider and Pillion
Front	1.75 kgf/cm ² (25 psi)	1.75 kgf/cm ² (25 psi)
Rear	2.00 kgf/cm ² (29 psi)	2.30 kgf/cm ² (33 psi)

CAUTION

Over inflation/Under inflation will affect the performance.



(1) Air pressure gauge

Inspection

Whenever you check the tyre pressure, you should also examine tyre treads & side walls for wear, damage & foreign objects.

Look for:

- Bumps or bulges in the side of the tyre or the tread. Replace the tyre if you find any bumps or bulges.
- Cuts, splits or cracks in the tyre. Replace the tyre if you can see fabric or cord.

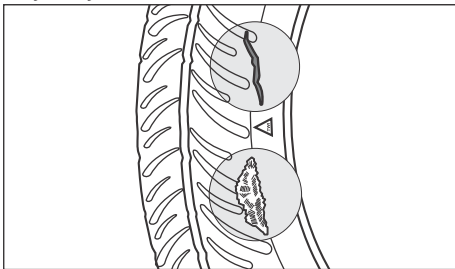

- Excessive tread wear.

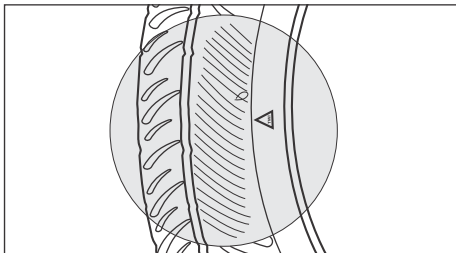

- Carefully inspect the tyres for any damage, if the vehicle hits a pothole or hard object.

Tread wear

Replace tyres immediately when the tread wear indicator (1) appears on the tyre. The tread limits are:

MINIMUM TREAD DEPTH:

Front: 1.0 mm

Rear: 1.0 mm

Check the tread wear indicator for tyre wear.

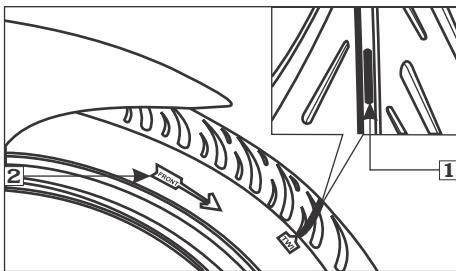

(1) Tread wear indicator

(2) Arrow mark

Unidirectional tyres

Whenever the tyre is removed and put back in case of puncture, ensure the arrow mark (2) on the tyre is in the same direction as that of forward rotation of wheel.

Tyre repair

Repairing a puncture or removing a wheel requires special tools and technical expertise. If a tyre is punctured or damaged, it is advised to visit nearest tyre manufacture, Hero MotoCorp authorised dealer/workshop or the tyre repair shop who has expertise in repairing methods of tubeless tyre.

A tyre that is repaired either temporarily or permanently, will have lower speed and performance limits than a new tyre. After an emergency repair, always have the tyre inspected/replaced at our authorised dealer and replace the tyre if suggested.

You should not exceed **70 km/hour** for the **1st 24 hours** or **105 km/hour** at any time thereafter. In addition, you may not be able to safely carry as much load as with a new tyre. If you decide to have a tyre replace be sure the wheel is balanced before you ride.

Tyre replacement

The tyres that were installed on your vehicle were designed to match the performance capabilities of your vehicle and provide the best combination of handling, braking, durability and comfort.



WARNING

- **Operation with excessively worn tyres is hazardous and will adversely affect traction and handling.**
- **Under-inflation may result in the tyre slipping on or tyre coming off the rim.**
- **Always use the size and type of tyres recommended in this owner's manual.**



NOTE

For repair and replacement of tyre it is advised to visit your Authorised Hero MotoCorp workshop.



NOTE

The imported tyre(s) if fitted without ISI mark; are in compliance of BIS standard and Central Motor Vehicle Rules 1989, as declared by the Tyre manufacturer.

Important safety reminders

- Do not install a tube inside a tubeless tyre on this vehicle. Excessive heat buildup can cause the tube to burst.
- Use only tubeless tyres on this vehicle. The rims are designed for tubeless tyres, and during hard acceleration or braking, a tube-type tyre could slip on the rim and cause the tyre to rapidly deflate.

NUTS, BOLTS & FASTENERS

- Tighten bolts and nuts at regular interval shown in the maintenance schedule.
- Check that all chassis nuts and bolts are tightened to correct torque values.
- Check that all cotter pins, safety clips, hose clamps and cable stays are in place.



BATTERY

Refer to the safety precautions on (page 27).

Location

The battery is located behind the left side cover.

Specification

*MF Battery 12V-4Ah/ETZ5

It is not necessary to check the battery electrolyte level or add distilled water as the battery is a **Maintenance Free (sealed)** type. If your battery seems weak and electrolyte is leaking (causing hard starting or other electrical troubles), contact your Authorised Hero MotoCorp workshop.

*MF stands for **Maintenance Free**

NOTE



This symbol on the battery means that this product must not be treated as household waste.



This symbol on the battery means the old battery must be returned to your Authorised Hero MotoCorp workshop as it must be treated as recyclable material.

- *Battery is a Maintenance-Free (sealed) type and can be permanently damaged if the sealing strip is removed.*
- *An improperly disposed battery can be harmful to the environment and human health. Always confirm local regulations for battery disposal.*

Battery charging

Always visit your Authorised Hero MotoCorp workshop if you see any symptom of battery discharge as earliest as possible to get the battery charged. The battery has a tendency to discharge rapidly if optional electrical accessories are fitted on the vehicle.

Battery storage

- If in case your vehicle is not used for more than a month remove the battery, fully charge and store in a cool and dry place.
- If the battery is expected to be stored for more than two months, ensure to fully charge the battery once in a month.
- Always ensure the battery is fully charged before installation.

- Ensure the battery leads are properly connected to the battery terminals during installation.
- Pullout the battery (13) from the battery box.

Battery removal

- Make sure the ignition switch is “OFF” (⊗).
- Remove the seat (**pages 21**).
- Remove the left side cover screws (1) and remove the side cover (2) by releasing the tabs from the slots (3) and lugs from the grommets (4).

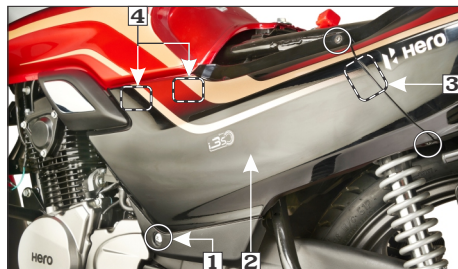

(1) Left side cover screws (2) Side cover
(3) Tab/slot (4) Lugs/grommets

- Remove the fuel tank left side cover bolt (5) and remove the cover (6) by releasing the tab (7) from the slot (8).
- Remove the battery clamp bolt (9) and the battery clamp (10).
- Disconnect the negative (-)ve terminal lead (11) from the battery first, then disconnect the positive (+)ve terminal lead (12).

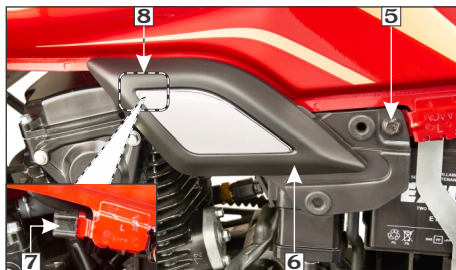

(5) Fuel tank left side cover bolt
(6) Fuel tank left side cover (7) Tab (8) Slot

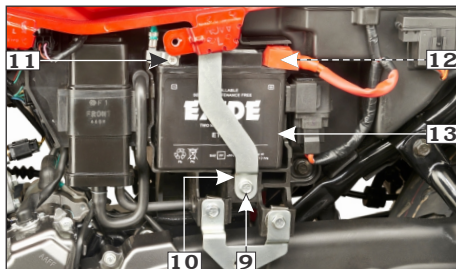

(9) Battery clamp bolt (10) Battery clamp
(11) (-)ve terminal (12) (+)ve terminal
(13) Battery

Battery installation

- Reinstall in the reverse order of removal. Be sure to connect the positive (+)ve terminal first, then the negative (-)ve terminal.
- Check all fasteners are secured properly.

FUSE REPLACEMENT

Fuse box (1): Location: Mounted on the air cleaner assembly (2) left hand side.

Fuse type: Blade fuse

Circuit fuse (3) : 15A, 10A, 10A

Spare fuse (4) : 15A, 10A

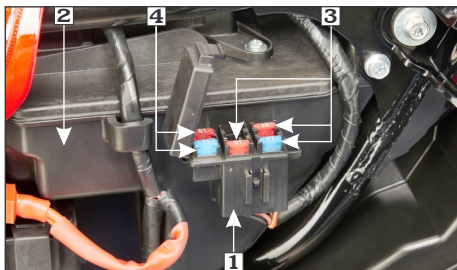

- (1) Fuse box (2) Air cleaner assembly
(3) Circuit fuse: 15A, 10A, 10A
(4) Spare fuse: 15A, 10A

⚠ WARNING

- **Never use a fuse with a different rating from that specified. It may lead to serious damage to the electrical system or a fire due to short circuit.**
- **Battery gives off explosive gases. Keep sparks, flames & cigarettes away.**

GOOD FUSE

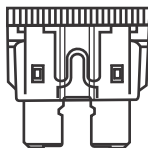

BLOWN FUSE

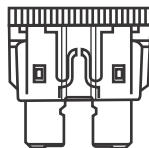

⚠ CAUTION

- **Do not attempt to start or ride the vehicle without a charged battery, it can cause fusing of the bulbs and permanent damage to certain electrical components.**
- **Turn the ignition switch "OFF" before checking or replacing the fuse to prevent accidental short-circuiting.**

STOP LAMP SWITCH

The stop lamp switch (1) must be adjusted so that stop lamp will glow when rear brake is applied. Rear brake free play (**page 46**) should be adjusted before performing stop lamp switch adjustment. The procedure for adjusting stop lamp switch is as follows:

- Turn the ignition switch to the "ON" (⊙) position.

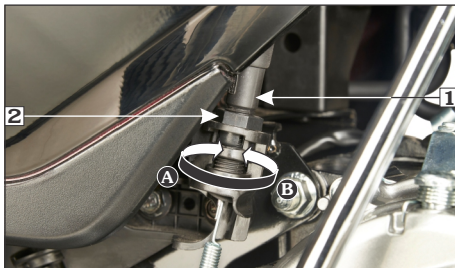

(1) Stop lamp switch **(2) Adjusting nut**
(A) Advance **(B) Retard**

- Turn the adjusting nut (2) to position stop lamp switch at a point where the stop lamp will glow just before the brake pedal is depressed to the limit of its free play. Turn the adjusting nut in direction (A) to advance switch timing or in direction (B) to retard switch timing.

HEADLAMP FOCUS ADJUSTMENT

Headlamp is factory preset. However in case of adjustment required, please follow the steps as given below:

- Headlamp adjustment is done by the headlamp adjusting bolt (1) located below headlamp.
- Park the vehicle on level ground.
- Turn the ignition switch to “ON” (O) position and start the engine.
- Adjust the headlamp beam vertically by loosening the bolt & move the headlamp unit forward & backward for correct focus adjustment.

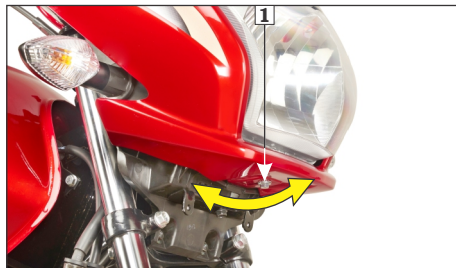

(1) Headlamp adjusting bolt

! WARNING

An improperly adjust headlamp may blind oncoming rider/driver or it may fail to light the road for a safe distance.

CATALYTIC CONVERTER

This vehicle is equipped with the catalytic converter in the muffler to meet the emission norms.

The catalytic converter contains precious metals that serve as catalysts, promoting chemical reactions to convert the exhaust gasses without affecting the metals. The catalytic converter acts on HC, CO and NOx.

The catalytic converter must operate at a high temperature for the chemical reactions to take place. It can set on fire any combustible material that come near it. Park your vehicle away from high grasses, dry leaves, or other flammable material.

A defective catalytic converter contributes to air pollution and can impair your engine's performance.

Follow these guidelines to protect your vehicle's catalytic converter.

- Always use unleaded petrol. Even a small amount of leaded petrol can contaminate the catalyst metals, making the catalytic converter ineffective.
- Keep the engine in good running condition. A poorly running engine can cause the catalytic converter to overheat.
- If your engine is misfiring, backfiring, stalling, or otherwise not running properly, stop riding and turn "OFF" the engine. Have your vehicle serviced as soon as possible.



(1) Catalytic converter

EVAPORATIVE EMISSION CONTROL SYSTEM

This vehicle is equipped with an evaporative emission control system to meet emission standards. During warm weather, the petrol

vapours which contain HC evaporates easily into the atmosphere from the fuel tank, if the fuel system is unsealed or open. The evaporative emission control system is used to prevent petrol vapours from escaping into the atmosphere from fuel tank. The canister (1) collects the fuel vapour from the fuel tank and then the fuel vapour is drawn into the engine for re-burning to avoid pollution caused by the fuel vapour diffused into the air.

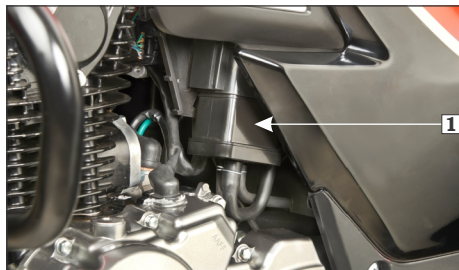

(1) Canister

POLISHING OF VEHICLE

After washing your vehicle, wax all painted surfaces (except matte painted surfaces) using a commercially available polish/quality liquid or paste wax to finish the job. Use only a non abrasive polish or wax made specifically for automobiles. Apply the polish or wax according to the instructions on the container.



NOTE

Polishing or waxing is not applicable for models having matte paint.

BASIC TROUBLESHOOTING

1. STARTING TROUBLE - ENGINE DOES NOT START

A. Fuel system

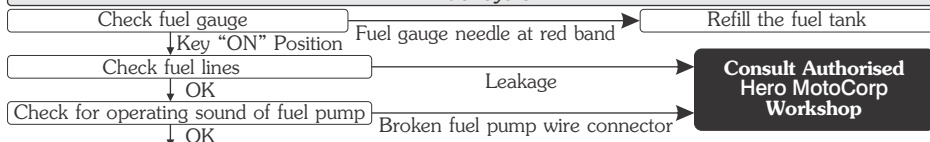

Consult Authorised Hero MotoCorp Workshop

B. Electric starter not working

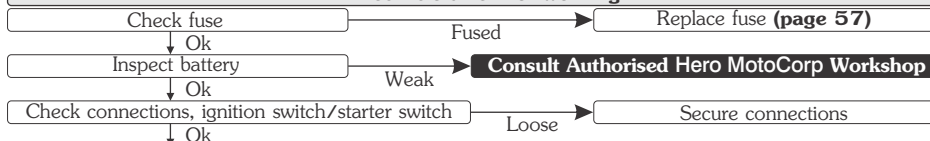

Consult Authorised Hero MotoCorp Workshop

C. No spark at spark plug

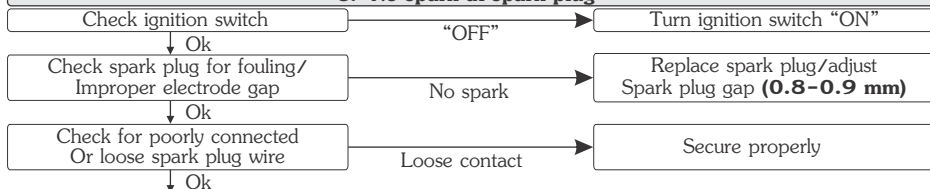

Consult Authorised Hero MotoCorp Workshop

2. ENGINE STARTS BUT STALLS



Consult Authorised Hero MotoCorp Workshop

BASIC TROUBLESHOOTING

3. POOR PICK UP

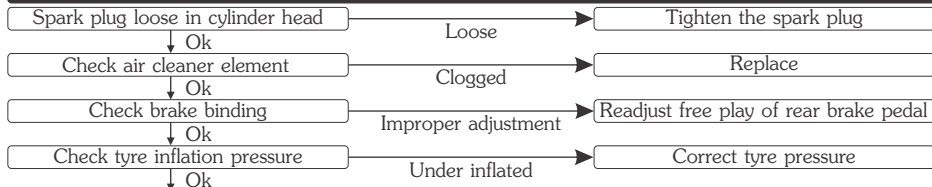

Consult Authorised Hero MotoCorp Workshop

4. ELECTRICAL SYSTEM

Feeble horn sound or no light

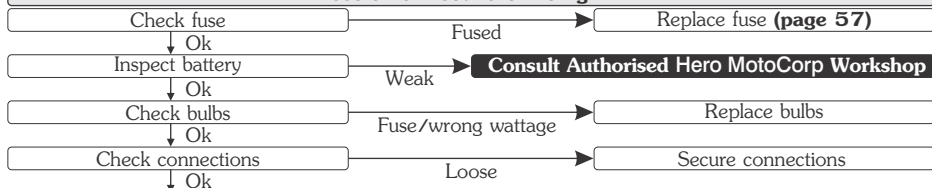

Consult Authorised Hero MotoCorp Workshop

5. i3s SYSTEM

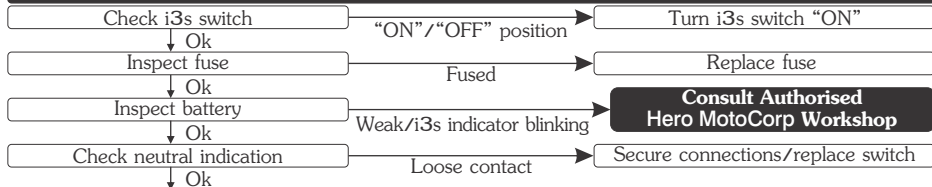

Consult Authorised Hero MotoCorp Workshop

ROAD SIGNS



Mandatory signs: These road signs inform drivers/riders of the traffic rules that apply on a certain stretch of road, thereby instructing them on how to drive/ride. Mandatory signs are distinguished by the bright red circle with black and blue markings. It is imperative that all riders follow these signs as they help avoid accidents. Their violation can be penalised under the Motor Vehicle Act.

Mandatory

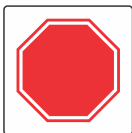

Stop



Give Way



One Way



No Horn



No Bicycles



No Automobiles



No Hand Craft



No Pedestrians



No Right Turn



No 'U' Turn



Overtaking Prohibited



Speed Limit



No Stopping
or Standing

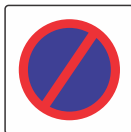

No Parking



Length Limit



High Limit



Restriction Ends



Compulsory-
Ahead Only

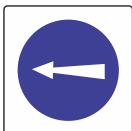

Compulsory-Turn
Left



Compulsory-Right
Ahead

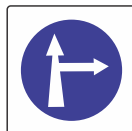

Compulsory-Ahead
or Turn Right

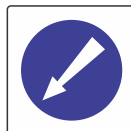

Compulsory-Keep
Left



Compulsory-Bicycle
Track



Compulsory-Sound
Horn

ROAD SIGNS



Cautionary signs: These signs inform the driver/rider of the road conditions ahead. Cautionary signs therefore serve as a warning. They are usually in a red triangle with black pictures on a white background. Illustrations, diagrams and symbols are used to forewarn about dangers ahead. Cautionary road signs are as important as mandatory signs. However, the violation of cautionary signs does not attract penalty.

Cautionary



Right Hand Curve



Right Reverse Bend



Incline Ahead



Narrow Road Ahead



Narrow Bridge



Pedestrian Crossing



School Ahead



Gap in Medium



Cross Road



Men at Work



Roundabout



Hump Road

ROAD SIGNS

Informatory signs: These are facility signs that provide important information about road directions are maps of specific destinations. On highways, they provide information about the location of public telephones, restaurants, hospitals, parking, petrol pumps, resting-places and more. These signs are usually rectangular, with black or white pictures on a blue background.

Informatory



Destination Sign



Hospital



First Aid Post



Petrol Pump



Eating Place



Resting Place



Public Telephone

Delhi

Place Identification Place



Light Refreshment



Taxi Stand



Parking Both Sides



Parking This Side



No Through Road



No Through Side Road

Bahadurgarh 10
Rohtak 48

Re-assure Sign

Signs and Signals are language of the road. Learn them, respect them.



Hero MotoCorp Ltd.

WARRANTY

Scope of warranty

Hero MotoCorp Ltd. (hereinafter called 'Hero MotoCorp') warrants its **SUPER SPLENDOR PROGRAMMED FI** vehicles, assembled/manufactured in its Plants and sold through its channel partners, to be free from any defect – both in material and workmanship, under normal use and conditions, subject to the following terms & conditions.

Terms & conditions

- a) **SUPER SPLENDOR PROGRAMMED FI** vehicle is warranted for a period of **5 years or 70000 Km**, whichever is earlier, from the date of purchase, emission warranty is separately covered under the head of "Emission Warranty".
- b) It is advised that the purchaser avails all free and paid services from the Hero MotoCorp's authorized workshop as per the recommended schedule, to be eligible for warranty benefits. Each paid service should be availed within **90** days from the date of previous service or as per the recommended schedule, whichever is earlier.
- c) If any problem is observed in **SUPER SPLENDOR PROGRAMMED FI** vehicle, Hero MotoCorp's only obligation/ liability is to repair or replace that part/those parts which is/are considered to be the cause of such problem, provided however that such problem has not resulted due to misuse/improper handling etc. of the vehicle. Any **SUPER SPLENDOR PROGRAMMED FI** vehicle needing repair should be brought along with owner's manual to Hero MotoCorp's authorized workshop for necessary inspection and carrying rectification job.



Hero MotoCorp Ltd.

LIMITATIONS OF WARRANTY

The warranty shall not apply—

- (1) If all free services/paid services/oil top-ups are not availed as per the recommended schedule at Hero MotoCorp's authorized workshop.
- (2) If any other engine oil which is non compatible with product is used other than SAE 10W30 SL Grade (JASO MA2).
- (3) To normal wear & tear components including (but not limited to) brake shoes/pads, clutch plates, drive chain & sprockets, bulbs, electrical wiring, filter, spark plug, fasteners, shims, washers, oil seals, gaskets, rubber parts, bush, rubber bellows, plastic parts breakage, wheel rim for misalignment/bend, steering ball race & cone, control cables such as brake cable/clutch cable, fuses (all types), steering handle for bend and sticker peel off.
- (4) If additional wheel(s) is/are fitted and/or any other modification carried out/unauthorized accessories fitted which shall be responsible for malfunction/deterioration of the vehicle.
- (5) If **SUPER SPLENDOR PROGRAMMED FI** vehicle has been used in any competitive events like races or rallies or for any commercial purposes as taxi etc.
- (6) To any damage on vehicle's painted surface cropping due to industrial pollution or other external factors.
- (7) For normal phenomena like noise vibration, oil seepage etc., which do not affect the performance of the vehicle.
- (8) To any damage caused due to usage of improper oil/grease, non-genuine parts.
- (9) If any defect crops or repairs needed as a result of using adulterated fuel.
- (10) If any maintenance/repairs required due to bad road conditions or misuse of **SUPER SPLENDOR PROGRAMMED FI** vehicle.
- (11) If any defect crops or repairs needed as a result of **SUPER SPLENDOR PROGRAMMED FI** vehicle meeting to some accident.
- (12) For consumables like oil, grease, gasket etc to be used during free services and/or warranty repairs.
- (13) To any part of the **SUPER SPLENDOR PROGRAMMED FI** vehicle which has been tampered or repaired in such a manner which has resulted in malfunction of the vehicle.
- (14) For **SUPER SPLENDOR PROGRAMMED FI** vehicle not used in accordance with the guidelines given in this Owner's Manual.
- (15) To proprietary items like Tyres, Tubes, Batteries etc, as they are subjected to the warranty terms & conditions of respective manufacturers and directly handled by them only.
- (16) Any defect(s) developing on account of external factors such as environmental factors; including but not limited to fading/peeling/rusting of paint and/or stripes and/or plated parts, seat leather tearing & cracking, aluminium parts oxidation and cracking & discoloring of control switches etc.

Decision regarding warranty settlement shall be taken by Hero MotoCorp and the same shall be final and binding on all concern.

Subject to DELHI JURISDICTION only.



Hero MotoCorp Ltd.

BATTERY WARRANTY PERIOD

1. 18 months from date of sale of vehicle or 20000 km. or
2. 21 months from the date of charging (whichever is earlier).
3. 3 months idle period is allowed from the date of charging to date of sale on vehicle.

Terms and condition of warranty

1. Batteries are warranted against all defects in material and workmanship. Liability under this warranty is limited to making good of defects rising solely from the use of faulty material or workmanship during manufacturing and developing under proper use. The warranty commences from the date of delivery to the original purchase of the vehicle.
2. In the event of any complaint the battery is to be returned complete with electrolyte to nearest battery service station or any OEM dealer. On inspection, battery would be returned or replaced.
3. This warranty card accompanies a battery sold as OEM fitment only. Claims should be supported with vehicle purchase invoice to enable processing.
4. The right to determine whether a battery needs repair or totally replacement lies with the company. In case where the battery is replaced, the defective battery becomes the property of the company and no scrap rebate will be given for it. The warranty period on the battery being repaired/replaced shall commence from the date of sale of the original battery as stated in the original warranty card.
5. All liabilities under this warranty will cease if the battery is used on the vehicle other than that on which the battery was originally fitted and on the expiry of the warranty period as mentioned above.
6. Recharging is not covered under the purview of this warranty and shall be billed as extra. However, FOC battery replacement/repair includes cost of charging.
7. This warranty does not cover damage to the battery caused by faulty electrical systems, incorrect charging and filling, improper handling of the battery by unauthorized dealers/auto electricians, maintenance, willfull abuse, destruction by fire, collusion, theft or recharging.
8. Breakage of container and cover do not come under the purview of this warranty.
9. Adjudication and settlement of claim will take a couple of days as a battery has to be tested for the reported failure.
10. In case of tempering of the original wiring circuit in any manner whatsoever.
11. If a battery which is not recommended is fitted on the vehicle then such battery will not carry any warranty.
12. The applicable taxes which is leviable on the battery under repair or replacement will be borne by the customer.
13. Customers are deemed to have read, understood and agreed to these conditions at the time of purchase of the vehicle.



Hero MotoCorp Ltd.

EMISSION WARRANTY

Scope of warranty

Hero MotoCorp Ltd. Warrants all its vehicles, assembled/manufactured at its various Plants and sold through its channel partners, to comply with emission standards as specified in sub rule (2) of Rule 115 of Central Motor Vehicles Rules, 1989, subject to following terms & conditions.

Terms & conditions

- a) The emission warranty shall be applicable in India and shall remain valid for a period of 3 years or 30000 km, whichever occurs earlier, from the date of vehicle purchase.
- b) In case any defect is observed in any emission-related component which are covered under emission warranty, Hero MotoCorp only obligation/liability shall be to repair and/or replace those part (s) which is/are considered to be the cause of non-compliance with the emission standards.
- c) The method (s) of examination to determine the warranty conditions of the emission warranty related component will be at the sole discretion of Hero MotoCorp Ltd. and / or Channel Partners / service center and result of such examination shall be final and binding. If on examination the warranty conditions of the part (s) is / are not established, Hero MotoCorp Ltd. will have the right to charge all, or part of the cost of such examination / service charges to the customer in addition to the cost of the components.
- d) Hero MotoCorp Ltd. shall have the sole discretion to decide to replace the defective components or the entire assembly or any other part required for such repair.
- e) The emission warranty shall be applicable only to those vehicles, which are being regularly maintained in accordance with the maintenance schedule provided in the owner's manual.
- f) The customer should follow the recommended parts replacement as per the maintenance schedule in order to avail the emission warranty.
- g) If any part (s) related to emission characteristics of the vehicles is/are tampered and/or repaired by unauthorized person/workshops etc, then the emission warranty shall stand cancelled.
- h) Any part (s) suffering wear and tear under the normal course of running shall not be covered under the emission warranty. Therefore, all such parts should be replaced by the customer from time to time, on payment basis, as per the maintenance schedule provided in owner's manual and dealer's advice
- i) It is recommended to avail the services as per the recommended schedule to be eligible for the emission warranty benefits. Please ensure that each paid service is availed within 90 days from the date of previous services or as per the recommended schedule, whichever is earlier. All service details should be completely filled by the dealer, in the **Service Record Sheet** given in the owner's manual.



Hero MotoCorp Ltd.

EMISSION WARRANTY

- j) It is mandatory to obtain a PUC certificate from the Authorised PUC center. In case of non-compliance with the emission standards please contact the channel partner/authorised workshop immediately along with the previous OK certificate, for the necessary rectification. The manufacturer or the dealer is not responsible for any penalty levied on you on account of non-compliance with the emission standards.
- k) The parts, which are covered under emission warranty are fuel injector, fuel pump, throttle body, ignition coil, oxygen sensor and muffler.
- l) Emission warranty shall not be applicable if
- The vehicle has been subjected to abnormal use, abuse, neglect and improper maintenance or has met with an accident.
 - The vehicle, or parts thereof, has been altered, tampered with or modified or replaced in an unauthorized manner.
 - The odometer is not functioning or the odometer and/or its reading has been changed/tampered with, so that the actual distance covered cannot be readily determined.
 - The vehicle has been used for competitions, races, and rallies or for the purpose of establishing records.
- m) All decisions regarding emission warranty settlement shall be taken by Hero MotoCorp Ltd. and shall be final binding on all concerned.

Subject to Delhi jurisdiction only.



WHAT ARE THE BENEFITS OF Hero MotoCorp GENUINE SPARE PARTS ?

- Assures long life
- Ensures economy for a long time
- Safety of vehicle and rider
- Peace of mind
- Value for money
- Assured quality

CONSEQUENTIAL DAMAGES ON USING NON-GENUINE PARTS

Clutch plate	<ul style="list-style-type: none">• Material used is inferior• Damages other parts of clutch like, clutch center and outer clutch• Affects fuel efficiency• Poor acceleration
Cam chain kit	<ul style="list-style-type: none">• Poor performance• Reduced life
Gasket cylinder head	<ul style="list-style-type: none">• Improper sealing• Engine knocking• Leads to leakage and smoky exhaust• Higher emission level



CONSEQUENTIAL DAMAGES ON USING NON-GENUINE PARTS

Element air cleaner	<ul style="list-style-type: none">• Improper air filtration resulting in premature engine failure• Affects fuel efficiency• Poor engine performance
Spark plug	<ul style="list-style-type: none">• Frequent stalling of engine• Higher emission level• Poor engine performance• Affects fuel efficiency
Brake pads/Shoes	<ul style="list-style-type: none">• Poor braking efficiency• Rider safety—an issue• Discs/Drum wear out, resulting in subsequent repair cost
Chain sprocket kit	<ul style="list-style-type: none">• Noisy operation• Failure of chain can cause fatal accident

ZONAL/REGIONAL/AREA OFFICES

For any of your service related query/requirements you may contact the respective Zonal/Regional/Area Offices

CENTRAL ZONE

Hero MotoCorp Ltd., No. 209-210, Ganpati Plaza, M.J. Road, Jaipur-302001, (Rajasthan).

Tel: +91 141 2389031, +91 141 2389156, E-mail: jaipur@heromotocorp.com

Hero MotoCorp Ltd., Office No. 705-706, 7th Floor, Fun Square, Durga Nursery Road, Udaipur -313001 (Rajasthan).

Tel: +91 0294-2980578, 79, E-mail: udaipur@heromotocorp.com

Hero MotoCorp Ltd., Office.No.401, 4th Floor, Offizo, Magneto Mall, Labhandi, G.E. Road, Raipur -492 001, (Chhattisgarh)

Tel: +91-771-4034749, E-mail: raipur@heromotocorp.com

Hero MotoCorp Ltd., Third Floor, Alankar Palace, Plot No. 11, Zone II, M.P. Nagar Bhopal-462011, India.

Tel: +91-755-4203160, 2553697, 4272429, 2550086, E-mail: bhopal@heromotocorp.com

Hero MotoCorp Ltd., Maloo-01, 601-602, 6th Floor, Plot No. 26C, Scheme No. 94, Ring Road, Indore, M.P.-452010,

Tel: +91-731-4978269, 70, E-mail: indore@heromotocorp.com

EAST ZONE

Hero MotoCorp Ltd., Flat No: 1002, 10th Floor, Martin Burn Business Park, BP3, Salt Lake, Sector-V, Kolkata-700091,

West Bengal, India. Tel : +91-33-44026841,+91-33-44026830, E-mail : kolkata@heromotocorp.com

Hero MotoCorp Ltd., Odysa Business Centre, Plot no. 30, 30/982, 172/1030, 4th Floor Cuttack, Bhubaneswar highway road,

Rasulgarh, Bhubaneswar-751010, Odisha, India. Tel: +91-674-2581161, 62, 63, 64, E-mail: bhubaneswar@heromotocorp.com

Hero MotoCorp Ltd., Yash Heights, 1st Floor Bariatu Road, Above Basudeb Tata Showroom Ranchi-834009, Jharkhand,

India. Tel: +91-651-2542222, 2542224, 2542225, E-mail: ranchi@heromotocorp.com

Hero MotoCorp Ltd., Sai Corporate Park, A Block, 6th Floor, Rukanpura, Bailey Road Patna, Bihar - 800014

Tel: +919334280555/7004569648 E-mail: patna@heromotocorp.com

NORTH ZONE

Hero MotoCorp Ltd., 3rd Floor, Tower-A, DLF Centre Court, Sector-42, Golf Course Road, DLF Phase 5,

Gurgaon -122002, Haryana, India. Tel: 0124-4754800, E-mail: delhi@heromotocorp.com

Hero MotoCorp Ltd., 602, 6th Floor, Office Tower-1, Plot No BW58, Logix City Center, Sector-32, Noida - 201301.

Tel: 0120-4631000, E-mail: noida@heromotocorp.com

Hero MotoCorp Ltd., S.C.O-367-368, First Floor, Sector-34A, Chandigarh-160022, India.

Tel: +91-172-2623773, 2623774, 2623775, E-mail: chandigarh@heromotocorp.com

Hero MotoCorp Ltd., Kapoor Towers, Plot No- 284, 15-B, Rajpur Road, Dehradun-248001, India.

Tel:0135-2714661,2713662,2714663, E-mail: dehradun@heromotocorp.com

ZONAL/REGIONAL/AREA OFFICES

NORTH ZONE

Hero MotoCorp Ltd., Summit Building (10th Floor) Plot No TCG 3/3 Vibhuti Khand, Gomti Nagar Lucknow – 226010, India. Tel: 0522-4006594, E-mail: lucknow@heromotocorp.com

Hero MotoCorp Ltd., C-19/134-B, Third Floor I.P Grand, Lallapura, Siga, Varanasi, Uttar Pradesh – 221010, India. Tel: +91-0542- 2390949,2390241, E-mail: varanasi@heromotocorp.com

SOUTH ZONE

Hero MotoCorp Ltd., SKAV 909, 3rd Floor, 9/1, Lavelle Road, Bangalore-560001, India. Tel: +91-80- 46881000, E-mail: bangalore@heromotocorp.com

Hero MotoCorp Ltd., 3-6-289, 3rd Floor, Kareem Manzil, Hyderguda, Hyderabad-500029, India. Tel:+91-40-23223735, 23223727, 23223570, E-mail: hyderabad@heromotocorp.com

Hero MotoCorp Ltd., 9th Floor Seshachalam Centre No.636/1, Anna Salai, Nandanam, Chennai-600035, India. Tel: +91-44- 24340974, 24340977, 24340978, E-mail: chennai@heromotocorp.com

Hero MotoCorp Ltd., 6-A, DD Trade Tower, (6th Floor), Kaloor-Kadavanthra Road, Kaloor-682 017, Kochi-682017, India. Tel: +91-0484- 4039646 -7, E-mail: cochin@heromotocorp.com

Hero MotoCorp Ltd., No 1547, 2nd Floor Classic Towers, Trichy Road, Coimbatore – 641018
Tel: +91-422-2200058, 2200061, E-mail: coimbatore@heromotocorp.com

Hero MotoCorp Ltd., First Floor VA Kalburgi Mahalakshmi Mansion, Mandakini Hospital Road, New Cotton Market, Hubli-580029, India. Tel: 0836-2269717, 2361038, E-mail: hubli@heromotocorp.com

Hero MotoCorp Ltd., D.NO. 54-11-18 E, 2nd Floor, Sai Oddesey Building, Opp Executive Club, Near NH-5, Vijayawada-520008, Andhra Pradesh, India. Tel: +91-866-2546859, 2546860, E-mail: vijayawada@heromotocorp.com

WEST ZONE

Hero MotoCorp Ltd., Chrome Building, Sr. No. 33, Hissa-A-1/1/2, Plot – 2, Viman Nagar Avenue 2, Nagar Road, Pune-411014, India. Tel: +91-020-71903500, E-mail: pune@heromotocorp.com

Hero MotoCorp Ltd., 603-604, Gunjan Tower, Off Alembic Gorwa Road, Baroda-390023, India. Tel: +91-265-2286569/2286570, E-mail: baroda@heromotocorp.com

Hero MotoCorp Ltd., Ground Floor, Block No.2, Vishnu Vaibhav Complex, 222, Palm Road, Civil Lines, Nagpur-440001, India. Tel: +91-712-2545990-91, E-mail: nagpur@heromotocorp.com

Hero MotoCorp Ltd., Astarc House-Third Floor, 76/79, Makwana Lane, Off. Andheri-Kurla Road, Andheri (East), Mumbai-400059, India. Tel: +91-22-28562071, E-mail: mumbai@heromotocorp.com

Hero MotoCorp Ltd., 604, Kings Plaza, Astron Chowk, Rajkot, Gujarat – 360001
Tel: 0281-2460622, 2460623, E-mail: rajkot@heromotocorp.com